

TOMCAT[®]

PRO

Operating Instructions (EN)

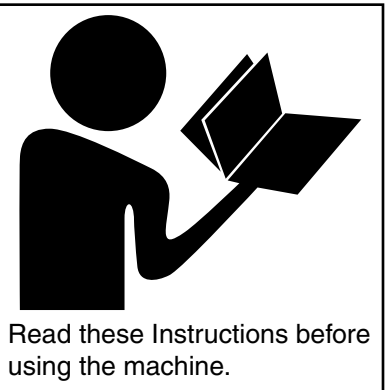
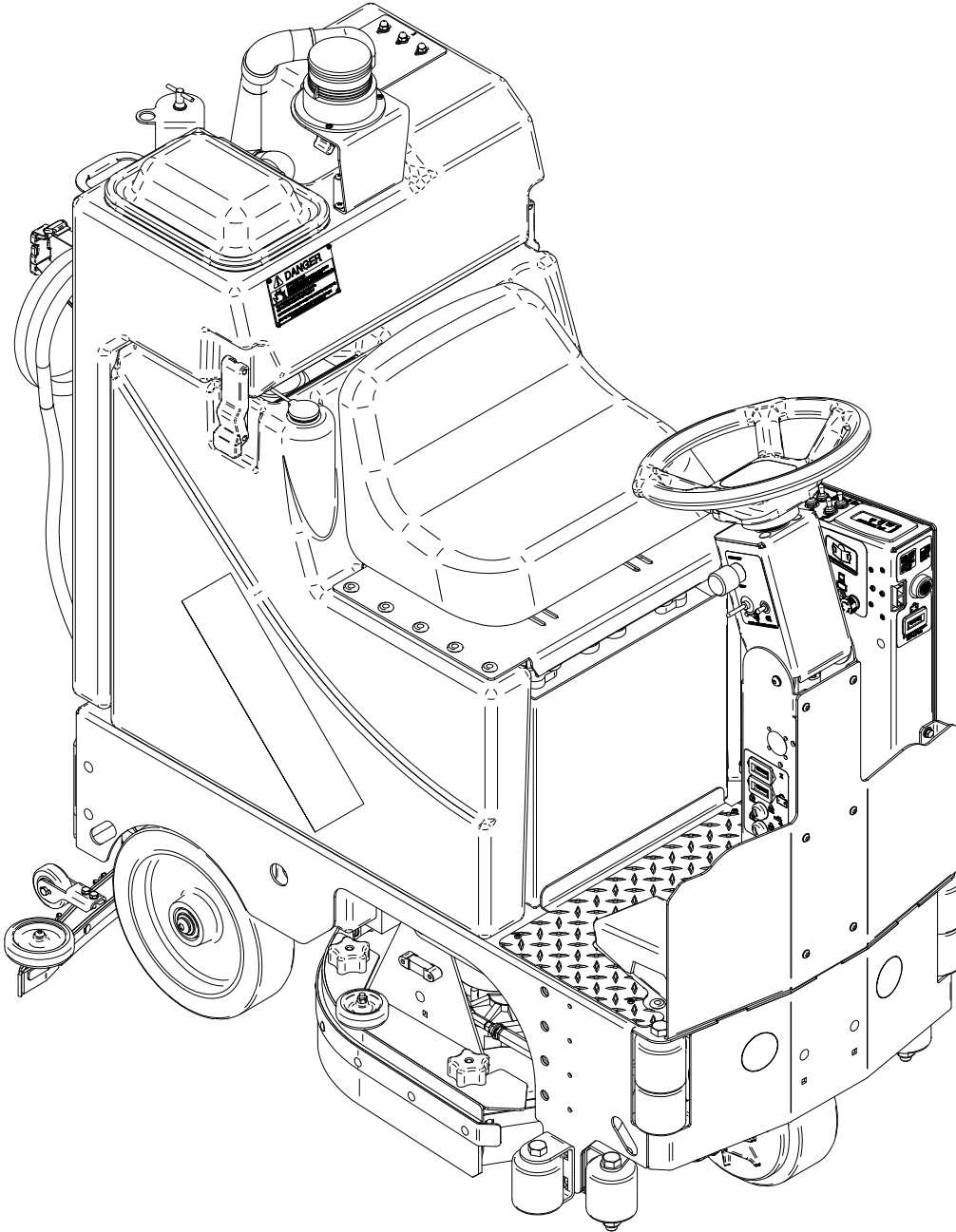

www.tomcatequip.com
1711 South Street
Racine, WI 53404 (USA)
(800) 450-9824 | (+001) 262-681-6470
© 2016 RPS Corporation

Scan With Phone for more Information



VERSION 16.224
TC-PRO-OP-EN

INTRODUCTION

This manual is furnished with each new machine. This manual will allow the Operator to get the best performance out of your RPS manufactured Scrubber-Drier, Sweeper, Burnisher, or Orbital Scrubber. Read this manual thoroughly before operating or servicing the machine.

This machine will provide excellent performance, but the best results will be obtained at the most minimum costs if:

- The machine is regularly maintained - per the Authorized Local Distributor.
- The machine is operated with reasonable care and caution.
- The machine is maintained with manufacturer supplied parts.

LOCATE SERIAL NUMBER

The serial number of your machine is located on the lower half of the control panel of the machine.

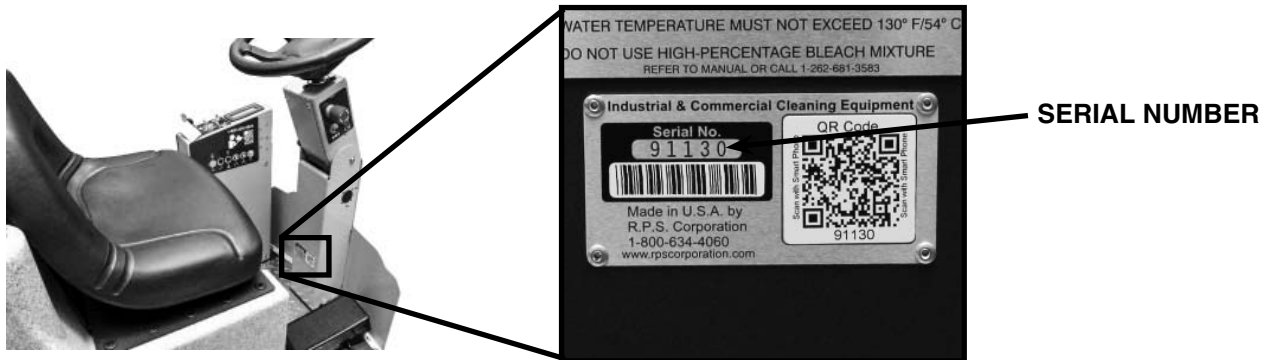

AS OUR POLICY IS ONE OF CONSTANT IMPROVEMENT - ALL INFORMATION AND SPECIFICATIONS ARE SUBJECT TO CHANGE WITHOUT NOTICE.

TABLE OF CONTENTS



| | | |
|--|--|----|
| | Introduction..... | 2 |
| | Locate Serial Number..... | 2 |
| | Table Of Contents..... | 3 |
| | Safety Messages..... | 4 |
| | Safety Labels..... | 6 |
| | LCD Screen..... | 7 |
| | Operation Controls..... | 8 |
| | Optional Controls..... | 9 |
| | Battery Setup..... | 10 |
| | Remove Squeegee..... | 11 |
| | Adjust Squeegee..... | 12 |
| | Remove From Battery Charger..... | 13 |
| | Transportation - Forward..... | 14 |
| | Transportation - Reverse..... | 15 |
| | Fill Solution Tank..... | 16 |
| | Operation - Scrubbing..... | 17 |
| | Draining Recovery Tank..... | 18 |
| | Draining Solution Tank..... | 19 |
| | Flushing Recovery Tank..... | 20 |
| | Clean Drain Saver..... | 21 |
| | Clean Cylindrical Hopper..... | 22 |
| | Clean Vac Box System..... | 23 |
| | Remove Disk Brushes..... | 24 |
| | Remove Cylindrical Brushes..... | 25 |
| | Charge Batteries..... | 26 |
| | Battery Chargers..... | 27 |
| | Common Wear Parts..... | 28 |
| | Round Disk Brushes:..... | 28 |
| | Round Disk Pads:..... | 28 |
| | Cylindrical Brushes:..... | 28 |
| | EDGE Pads and Screens:..... | 28 |
| | Squeegee Blade Kits & Complete Squeegee Assemblies:..... | 29 |



SAFETY MESSAGES

You will see four kinds of safety reminders in this manual:

DANGER

DANGER indicates a hazardous situation which, if not avoided, will result in death or serious injury.

CAUTION

CAUTION indicates a potentially hazardous situation which, if not avoided, could result in minor or moderate injury or damage to this machine or nearby objects. CAUTION also can be used to alert against unsafe practices.

WARNING

WARNING indicates a potentially hazardous situation which, if not avoided, could result in death or serious injury.

NOTICE

NOTICE indicates information considered important, but not hazard-related. This safety message may be related to property damage or warranty warnings.

Your safety, and that of others, is very important. Operating this machine safely is an important responsibility.

DO NOT OPERATE THIS MACHINE:

- Unless you are trained and authorized to do so by your RPS Authorized Local Distributor
- Unless you have read and understood this Operator's Manual
- On surfaces with greater than a 2% grade unless this machine is equipped with a functional parking brake
- On surfaces with greater than an 8% grade at any time
- On Loading Docks

WHEN OPERATING THIS MACHINE:

- Remove loose objects from the floor that could be projected from the rotating Brushes
- Keep your hands and feet away from the rotating Brushes
- Do not operate this machine where flammable liquids, vapors, or dust are present
- Use caution when maneuvering

BEFORE LEAVING THE MACHINE:

- Drain "clean" Solution & "dirty" Recovery solution into APPROVED drains
- Park the machine on a level surface
- Turn the machine off & remove key

BEFORE SERVICING THE MACHINE:

- Disconnect the Batteries

DANGER

Explosive hydrogen gas forms when Batteries are charging. An open flame or spark can cause this gas to explode. Serious personal injury or property damage could occur. Only charge the Batteries in this machine in a well ventilated area.

DANGER

Flammable materials can cause an explosion or fire. Do not use flammable materials in Tank or pick up.

! WARNING

The Batteries in this machine produce hazardous voltage which can cause electrical shock, burns and/or electrocution. Always disconnect Batteries before servicing this machine.

! WARNING

When climbing or descending ramps, always drive machine forward. To avoid overturning the machine, Do not back down ramps. Do not drive across inclines. Do not turn while ascending or descending ramps. Overturning the machine can cause serious injury or death.

! WARNING

Do not use water that exceeds 135°F / 57°C. If water is above said temperature, this will void the Tank Warranty.

! WARNING

Do not park this machine on ramps or slopes. Always park this machine on a level, hard surface. Do not operate this machine outdoors or on uneven surfaces.

! WARNING

The Batteries in this machine contain sulfuric acid, which causes burns to skin. If battery acid contacts clothing or skin, rinse the effected area with cold water immediately. If battery acid gets on your face or in your eyes, flush the area immediately with cold water and seek medical attention.

! WARNING

To avoid electrical shock, do not operate this machine over electrical floor outlets.

! CAUTION

To avoid damage to this machine, use only cleaning solutions and replacement parts recommended by the manufacturer.

! CAUTION

Do not operate this machine if any parts have been damaged or removed.

! WARNING

Dress safely. Do not wear rings or metal wrist watches when servicing this machine, as they can cause an electrical short circuit which can cause serious burns.

! WARNING

Do not remove, paint over or destroy warning decals. If warning decals become damaged, call 1-262-681-3583 for free replacements.

! WARNING

Dress safely. Do not wear a neck tie, scarf, or any loose or dangling clothing while operating this machine. Loose or dangling clothing or neck-wear can tangle in rotating parts, causing serious injury or death.

! WARNING

Always turn off this machine before leaving it unattended. Do not allow untrained persons to operate this machine.

! WARNING

NO RIDERS. Do not carry passengers on this machine. Do not use this machine as a stepladder or work platform.

! WARNING

Understand the dynamic braking system before you operate the machine on ramps. Machine may coast.

! WARNING

Before you service a Battery, always wear face protection, protective gloves and protective clothing. Battery acid or battery explosion can cause serious injuries.

! CAUTION

Always use the automatic battery charger provided by the manufacturer of this machine to charge the Batteries of this machine. It is designed to charge the Batteries at the appropriate rate. If you must use a different charger, disconnect the Batteries before charging to avoid damage to the electronic speed controller.

! CAUTION

To avoid damage to the electronic control components of this machine, Do not store this machine outdoors. Do not pressure wash this machine.



SAFETY LABELS

Read and obey all Safety Labels on your PRO Floor Scrubber. If you have questions about these labels, ask your supervisor.

These images indicate where on the PRO Safety Labels are located. If ever the labels become illegible, worn off, or torn, promptly report it to your supervisor and replace it.



TANK LABEL
PART #: 5-728

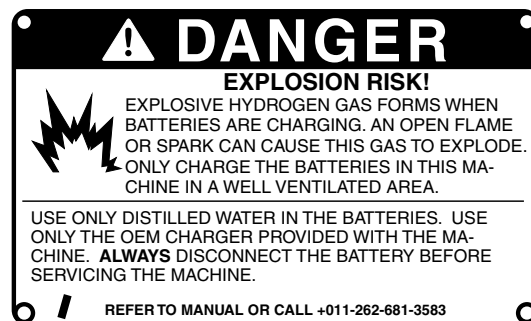

BATTERY CHARGING LABEL
PART #: 253-7280

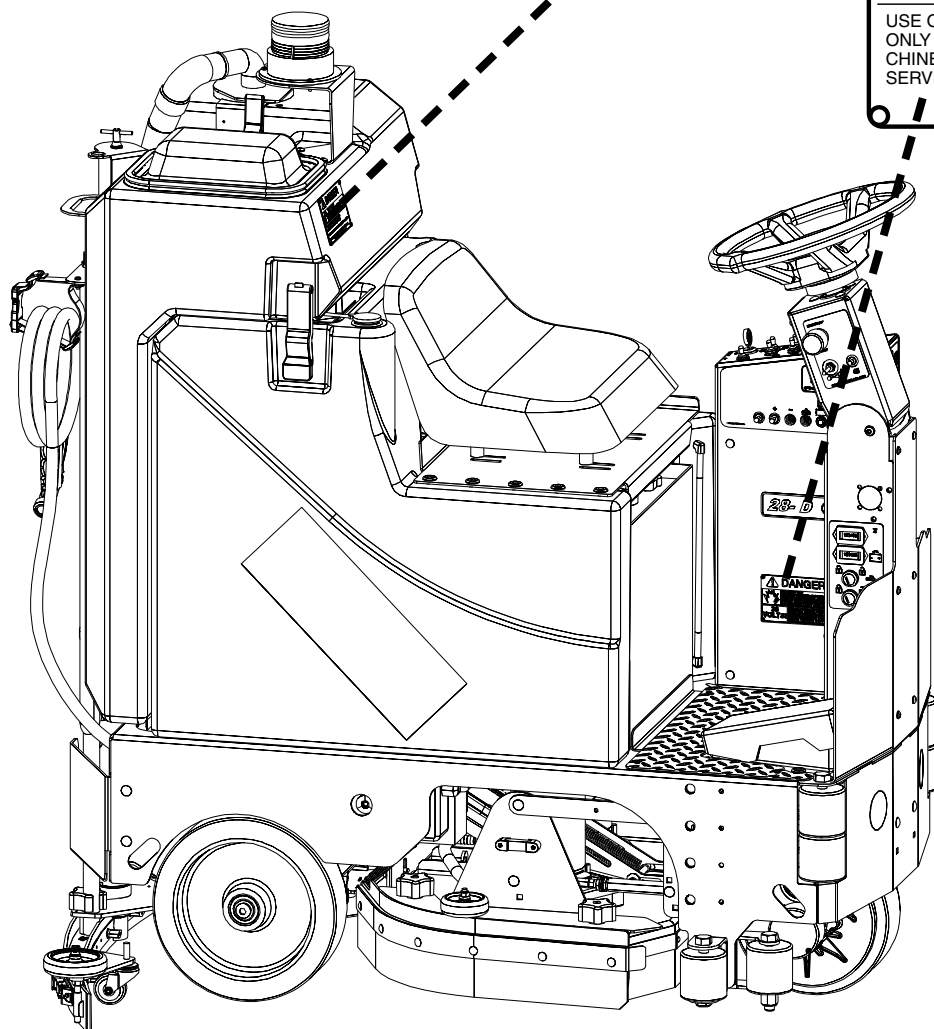

LCD SCREEN



SCREEN #1 (OPERATOR)

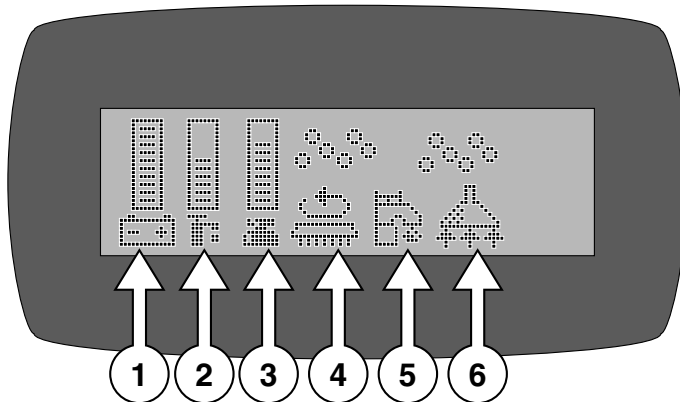

SCREEN #2 (MAINTENANCE)

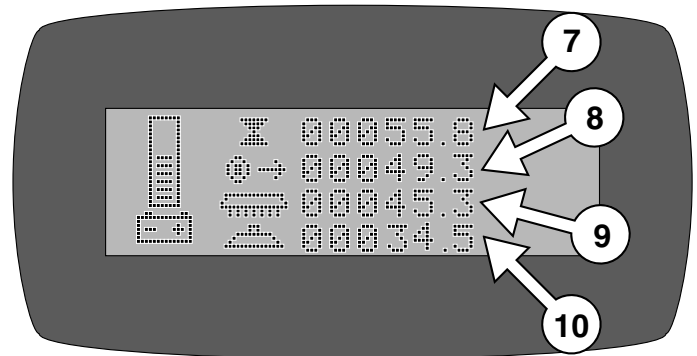

SCREEN #3 (WITH ERROR CODE)

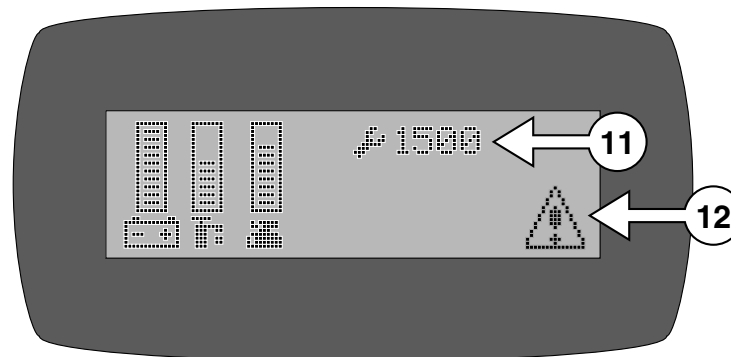

**** USE GREEN MENU SELECTION BUTTON ON CONTROL PANEL TO CHANGE SCREENS ****

1. **BATTERY LEVEL INDICATOR** - Indicates the energy level remaining in the Batteries (*Shown on all menu displays*)
2. **SOLUTION OUTPUT INDICATOR** - Indicates the gallons per minute (*GPM*) 0 - 1.0
3. **SCRUBDECK DOWN PRESSURE INDICATOR** - Sets the down pressure on the Brushes / Pads
4. **SCRUB MOTORS ON** - Indicates the Brush Motors are in operation
5. **SOLUTION ON** - Indicates the solution flow is *ON*
6. **VACUUM ON** - Indicates the Vacuum is *ON*
7. **KEY SWITCH HOUR METER** - Indicates total hours the machine has had keyswitch *ON*
8. **TRANSPORT HOUR METER** - Indicates total hours the drive system has been in operation
9. **SCRUB BRUSH HOUR METER** - Indicates total hours the brush motors have been in operation
10. **VACUUM HOUR METER** - Indicates total hours the vacuum motor has been used
11. **DIAGNOSTIC CODE** - Displays diagnostic code which helps troubleshoot issues
12. **ERROR WARNING SYMBOL** - Indicates when there has been a diagnostic code error



OPERATION CONTROLS

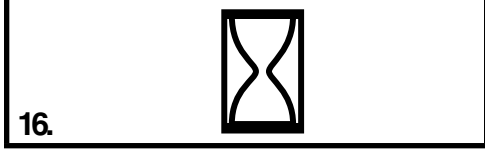
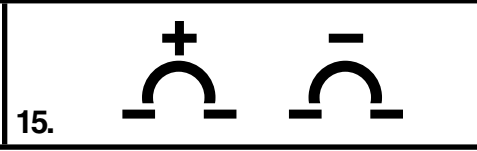
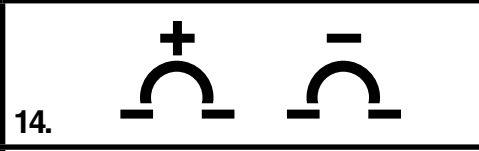
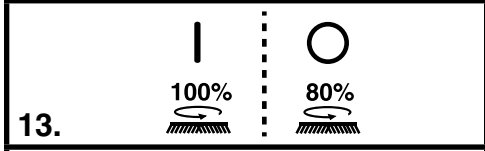
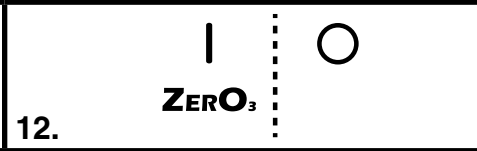
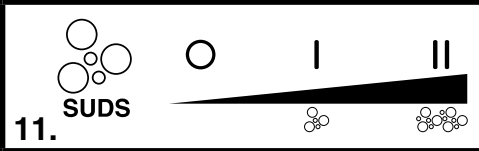
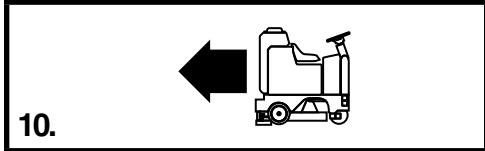
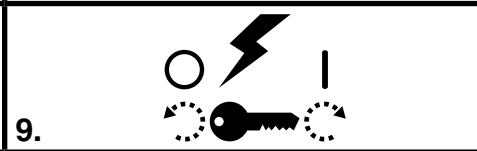
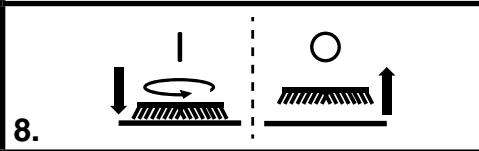
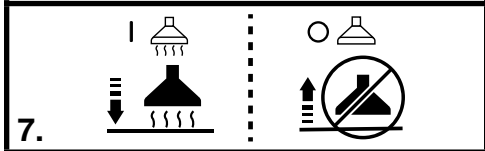
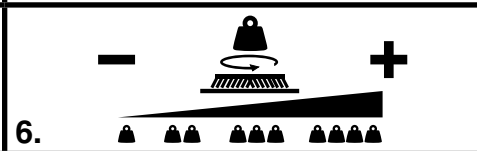
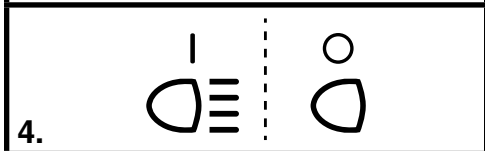
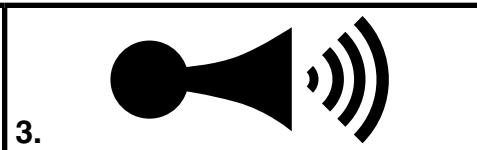
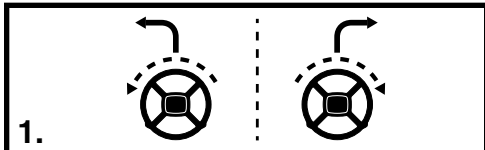
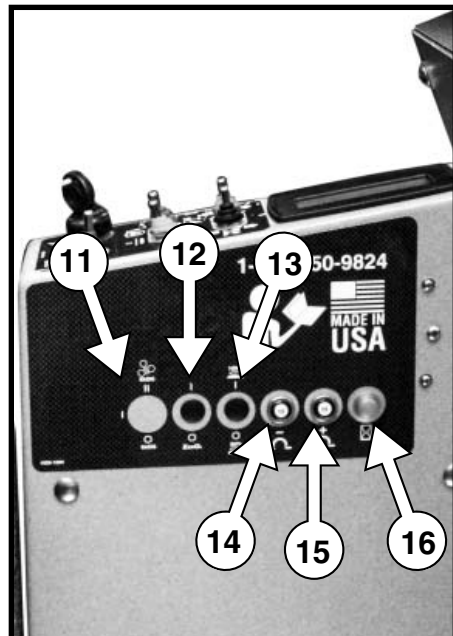
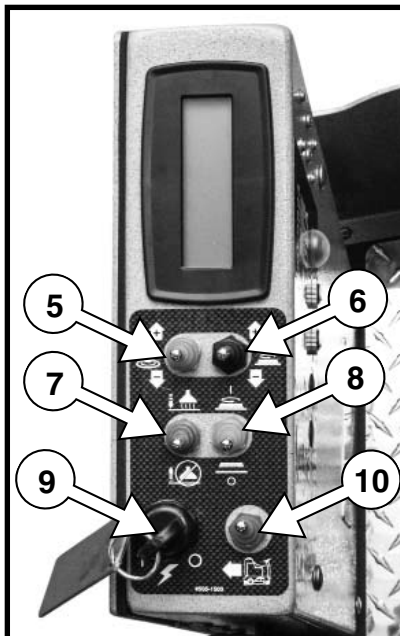
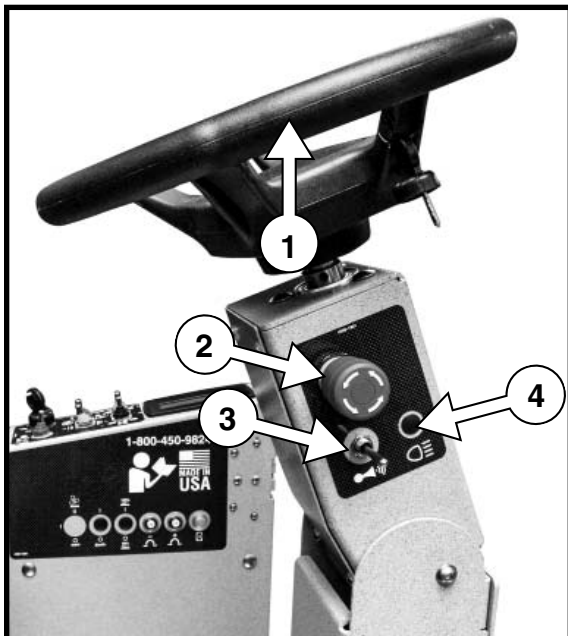

OPTIONAL CONTROLS

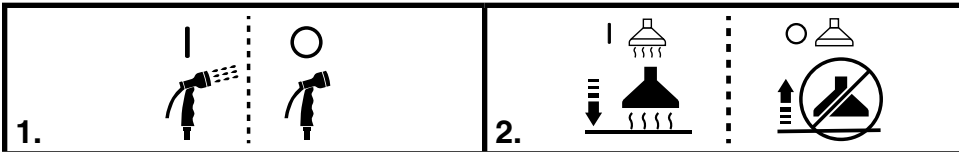
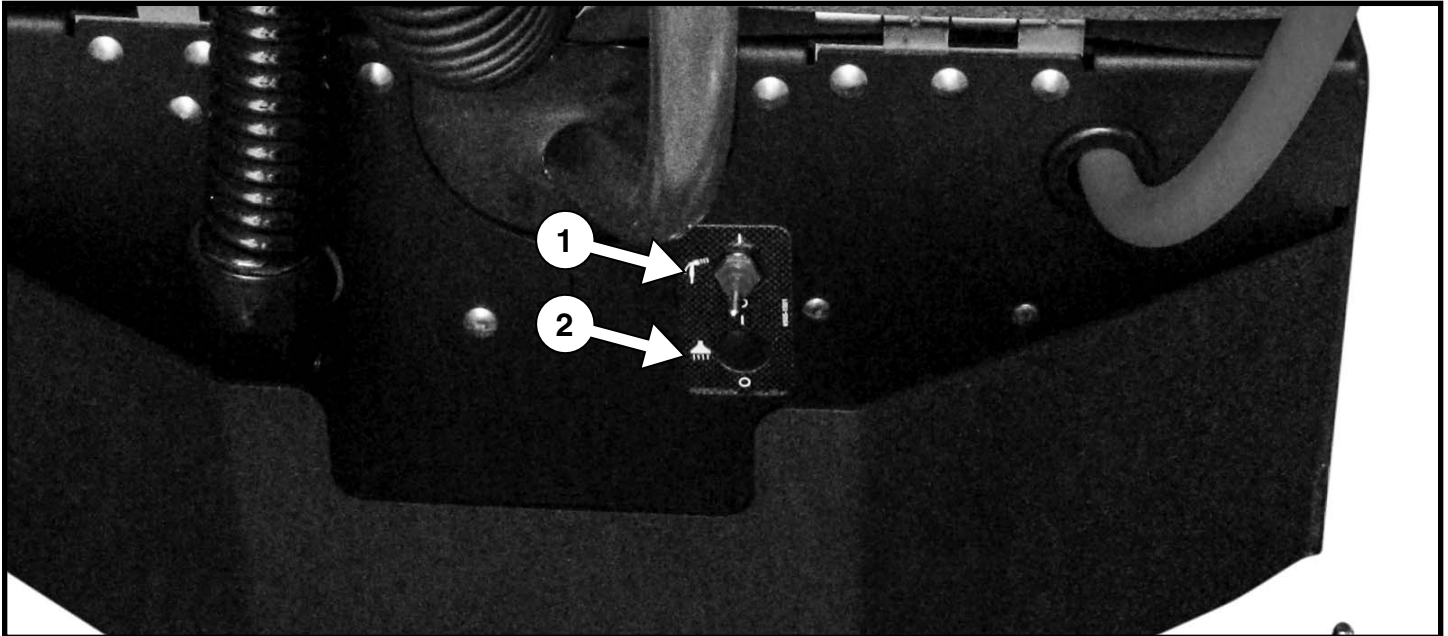
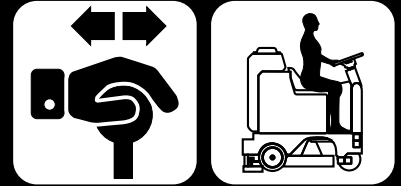

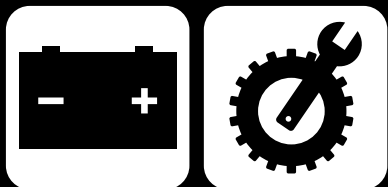

BATTERY SETUP

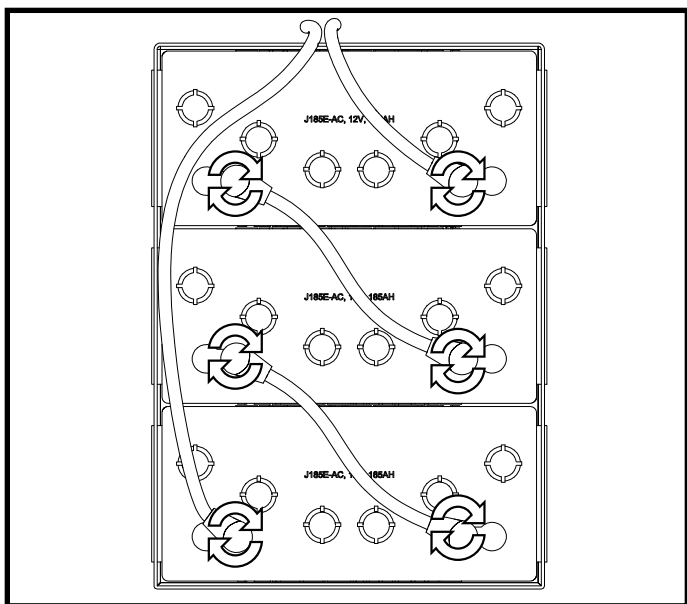
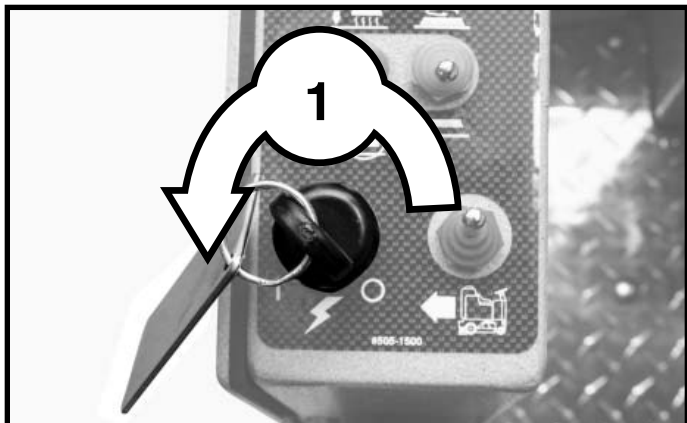

36 VOLTS

NOTICE

Batteries are a possible environmental hazard. Consult your Battery supplier for safe disposal methods.

NOTICE

Orientation of Batteries is critical for cables to reach. Ensure proper torque values when installing batteries. (Between 8 - 12 ft/lbs)

REMOVE SQUEEGEE

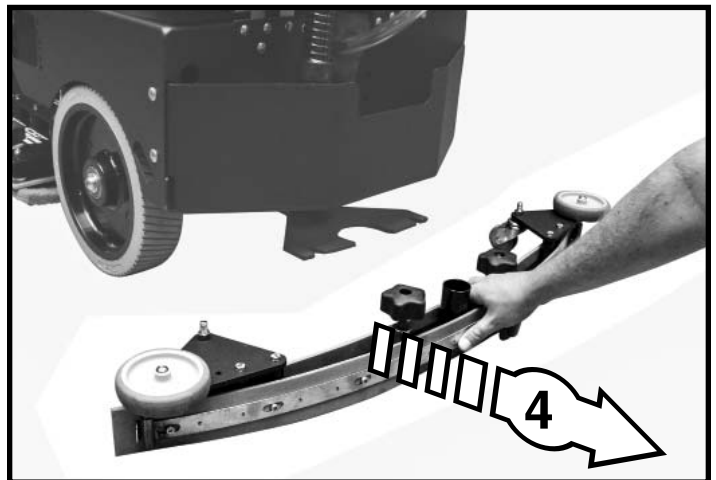
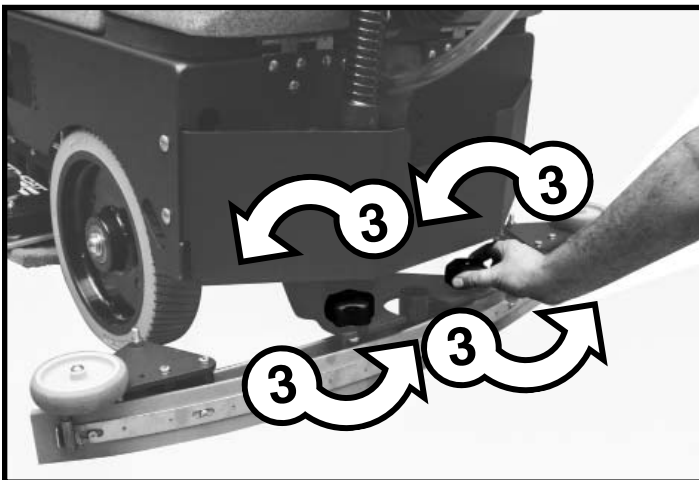
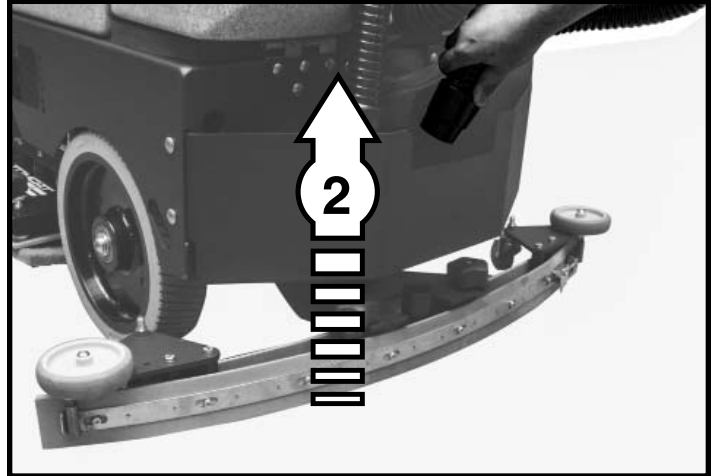
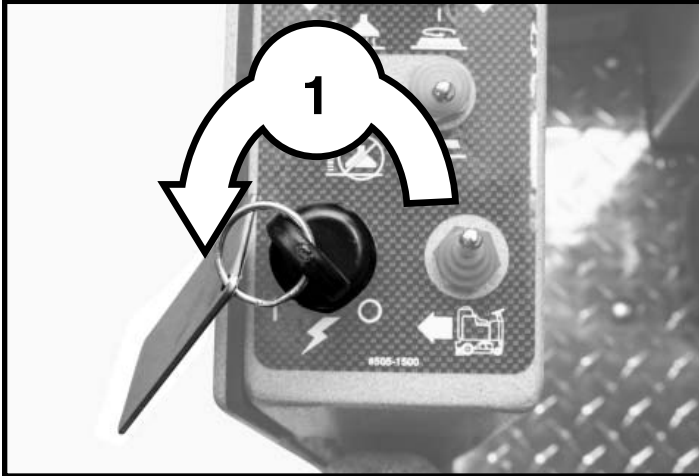



ADJUST SQUEEGEE

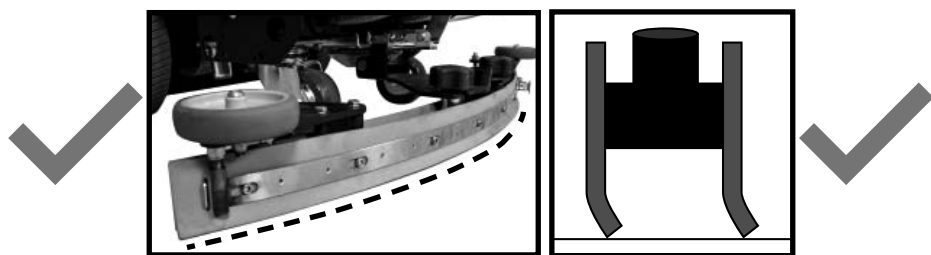
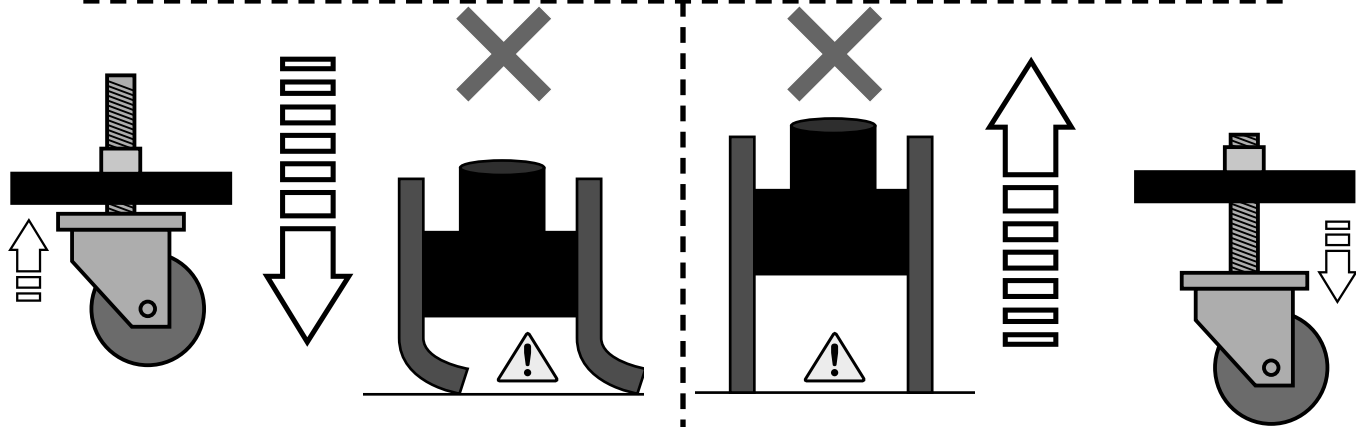
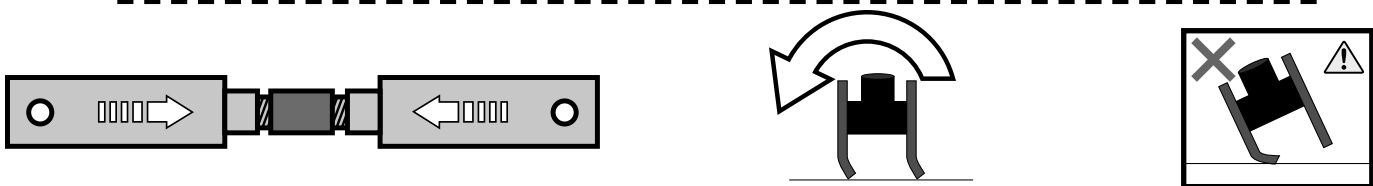
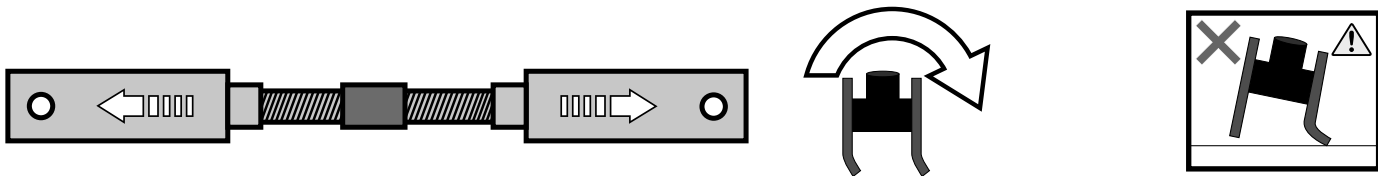
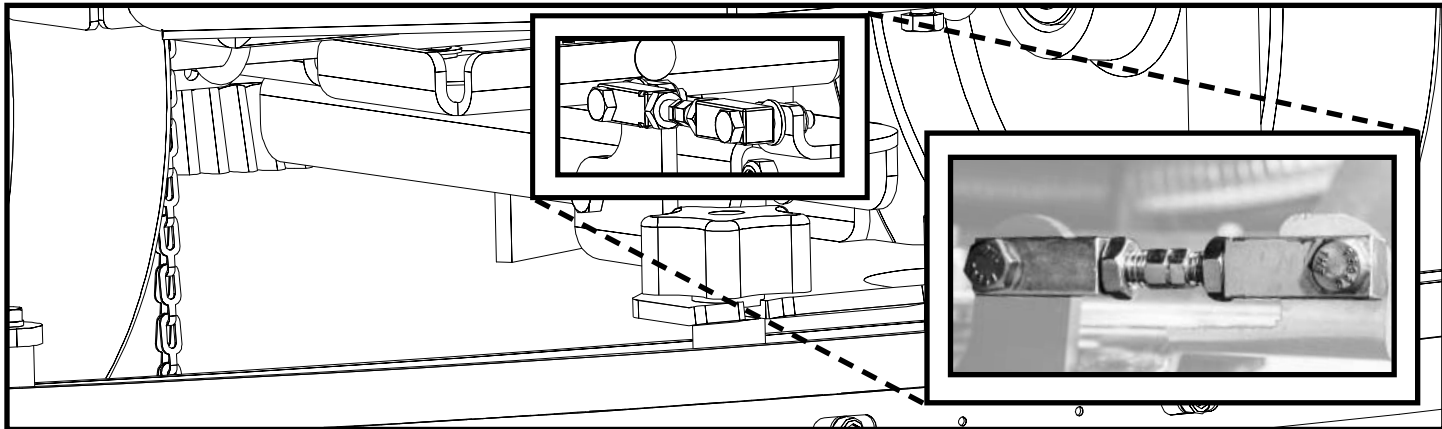

REMOVE FROM BATTERY CHARGER

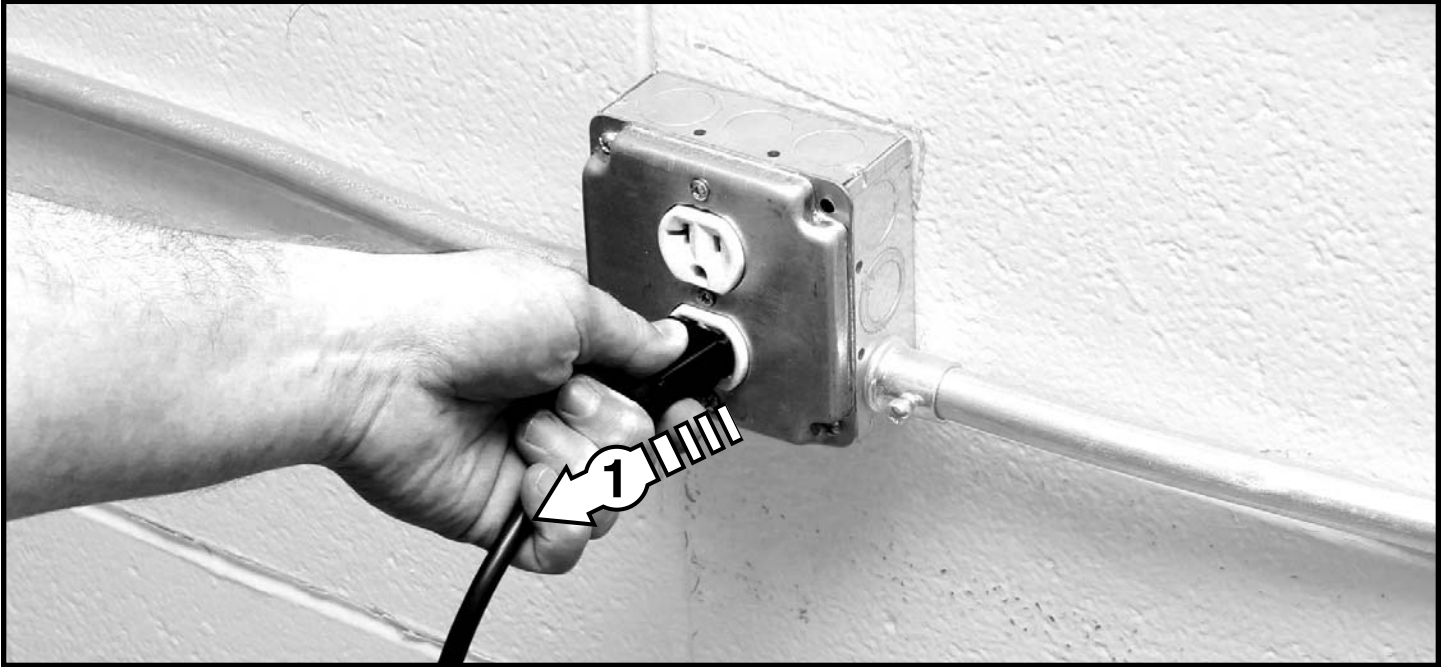
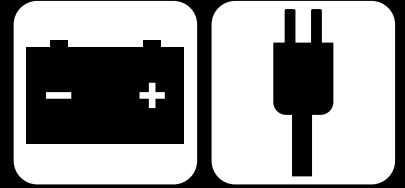

Please refer to OEM Charger Operating Instructions for more information.

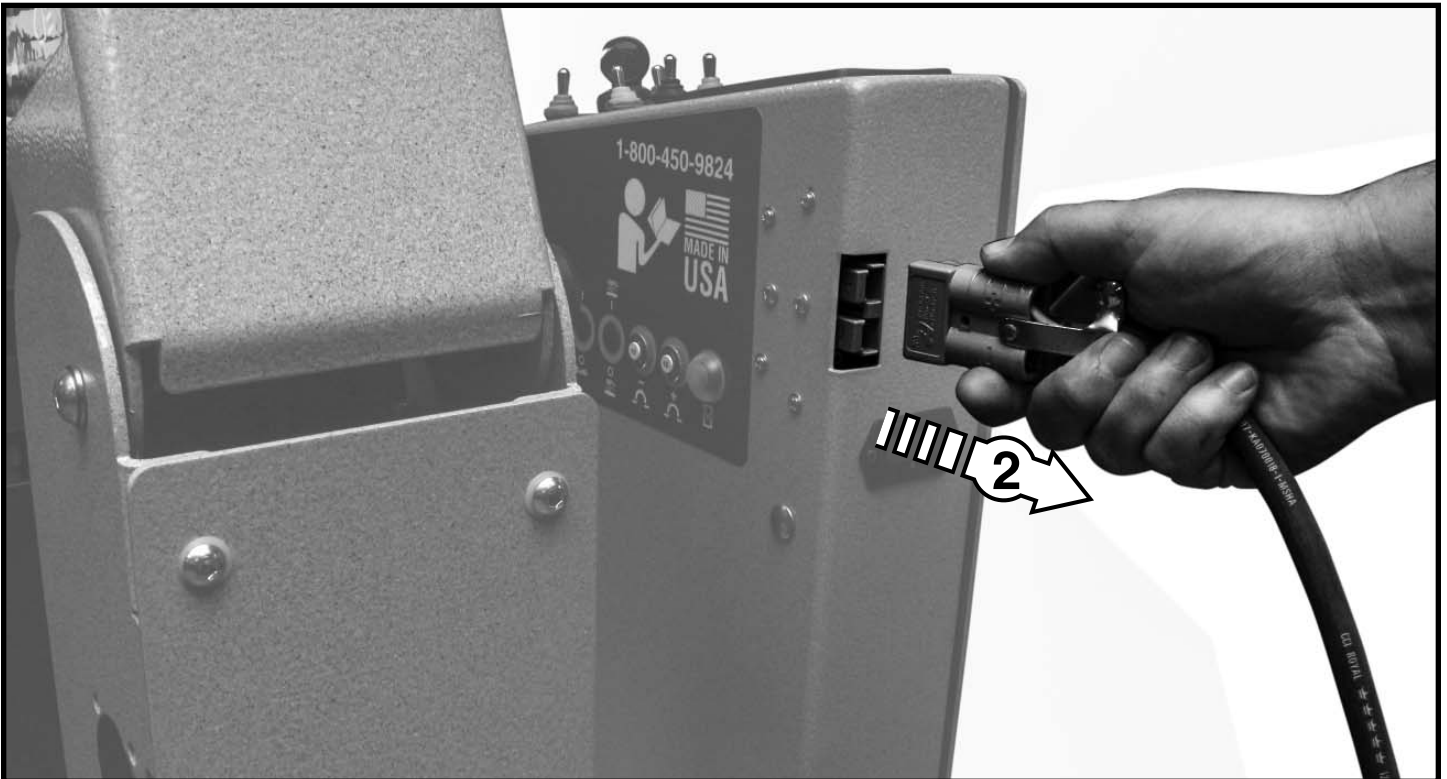



TRANSPORTATION - FORWARD

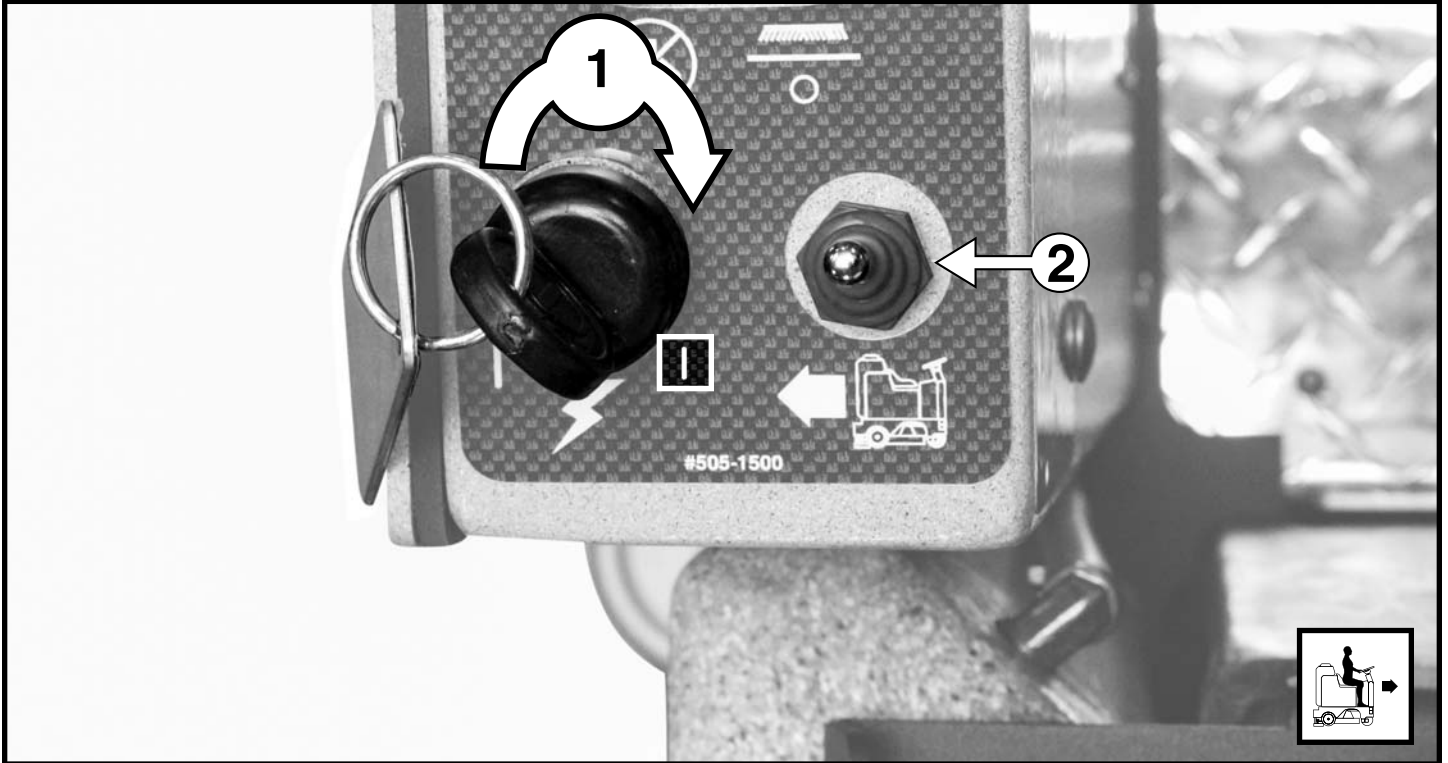

TRANSPORTATION - REVERSE

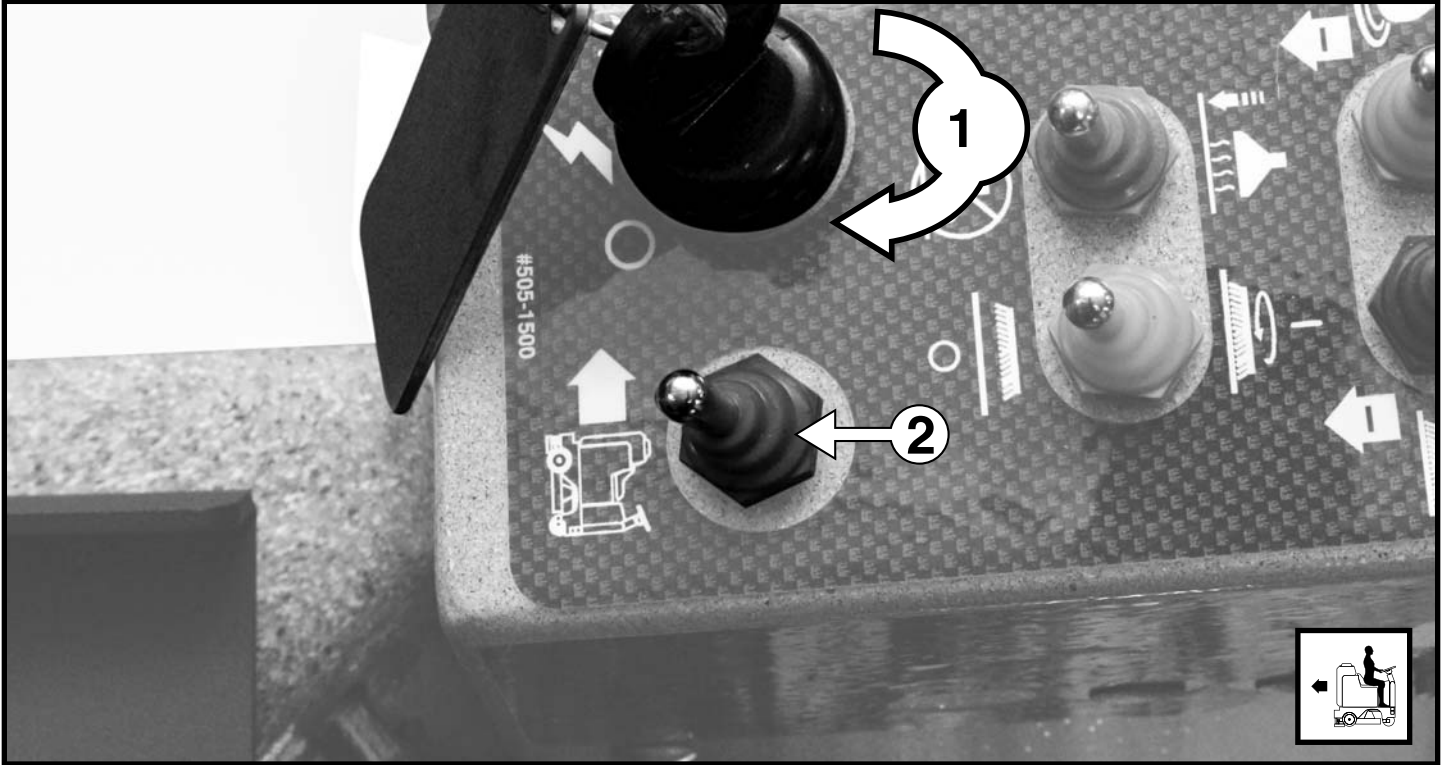

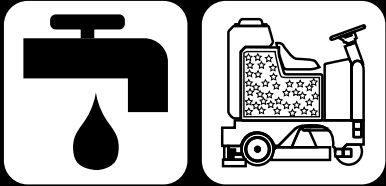

FILL SOLUTION TANK

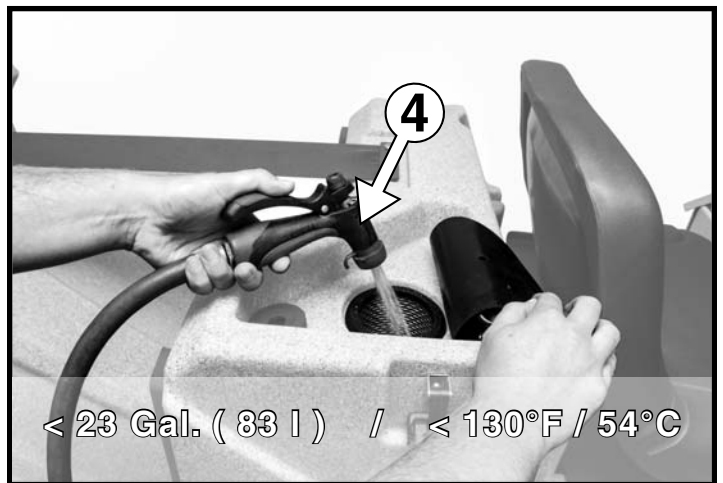
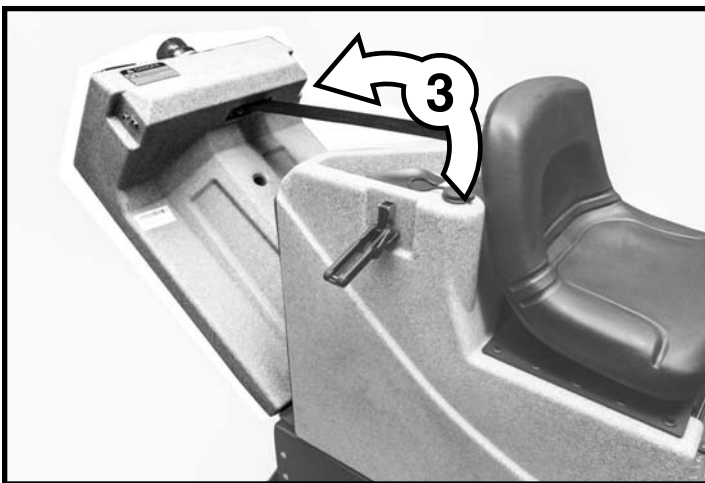
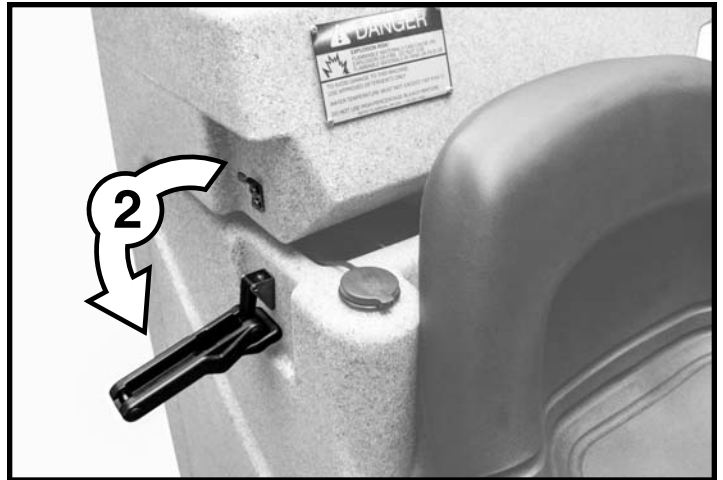
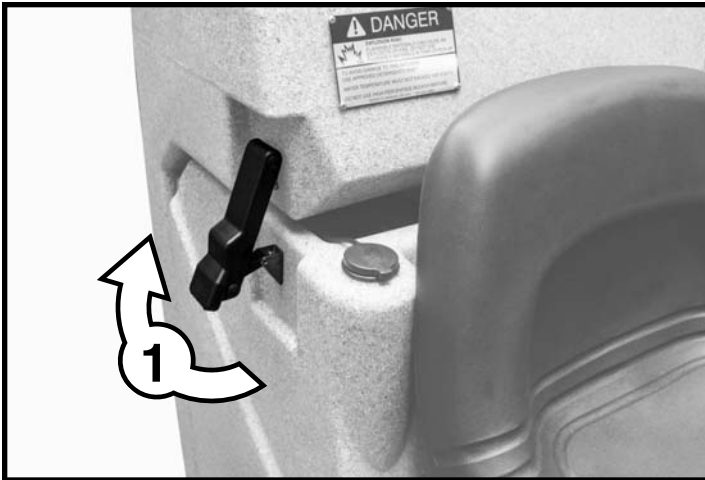

⚠ DANGER

EXPLOSION RISK! Flammable materials can cause an explosion or fire. Do NOT use flammable materials in Tank or pick up.

⚠ CAUTION

TO AVOID DAMAGE TO THIS MACHINE:

- Use APPROVED detergents only
- Water temperature must not exceed 130°F/54°C
- Do NOT use high-percentage Bleach mixture

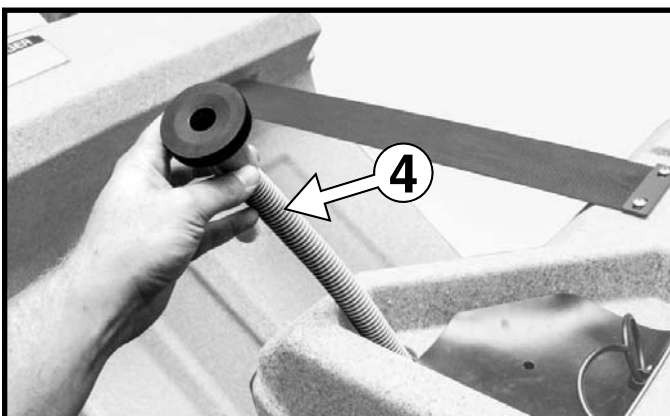

OPERATION - SCRUBBING

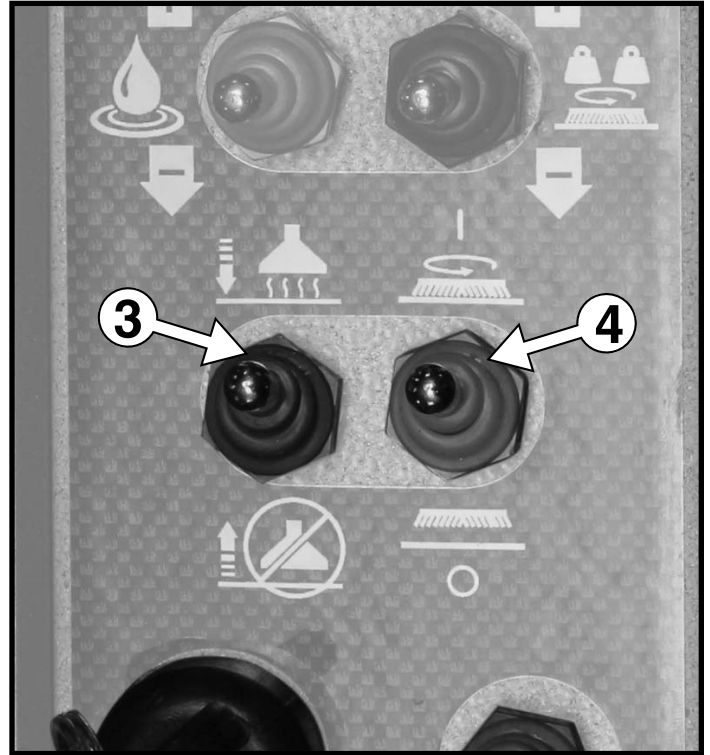
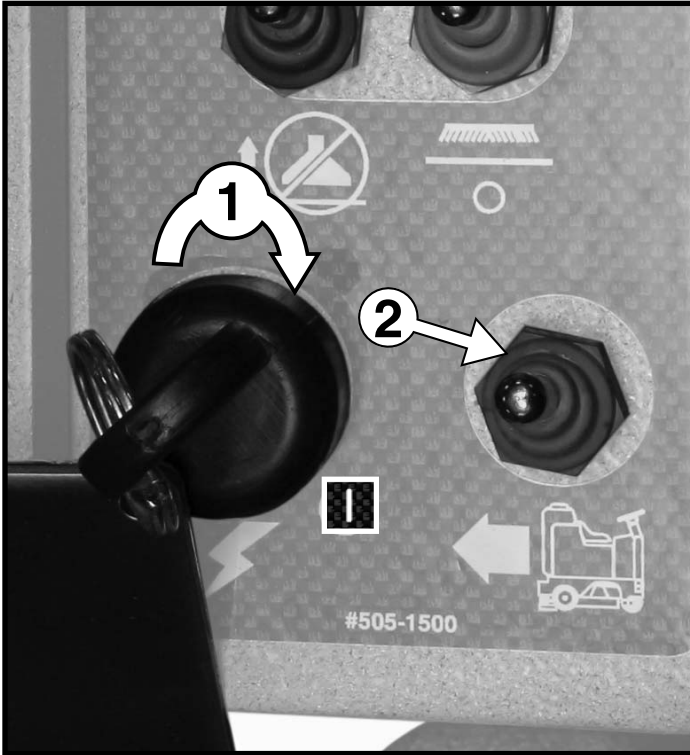
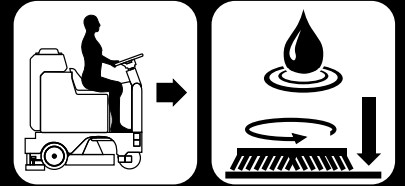

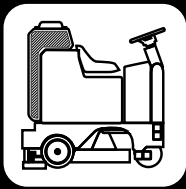

DRAINING RECOVERY TANK

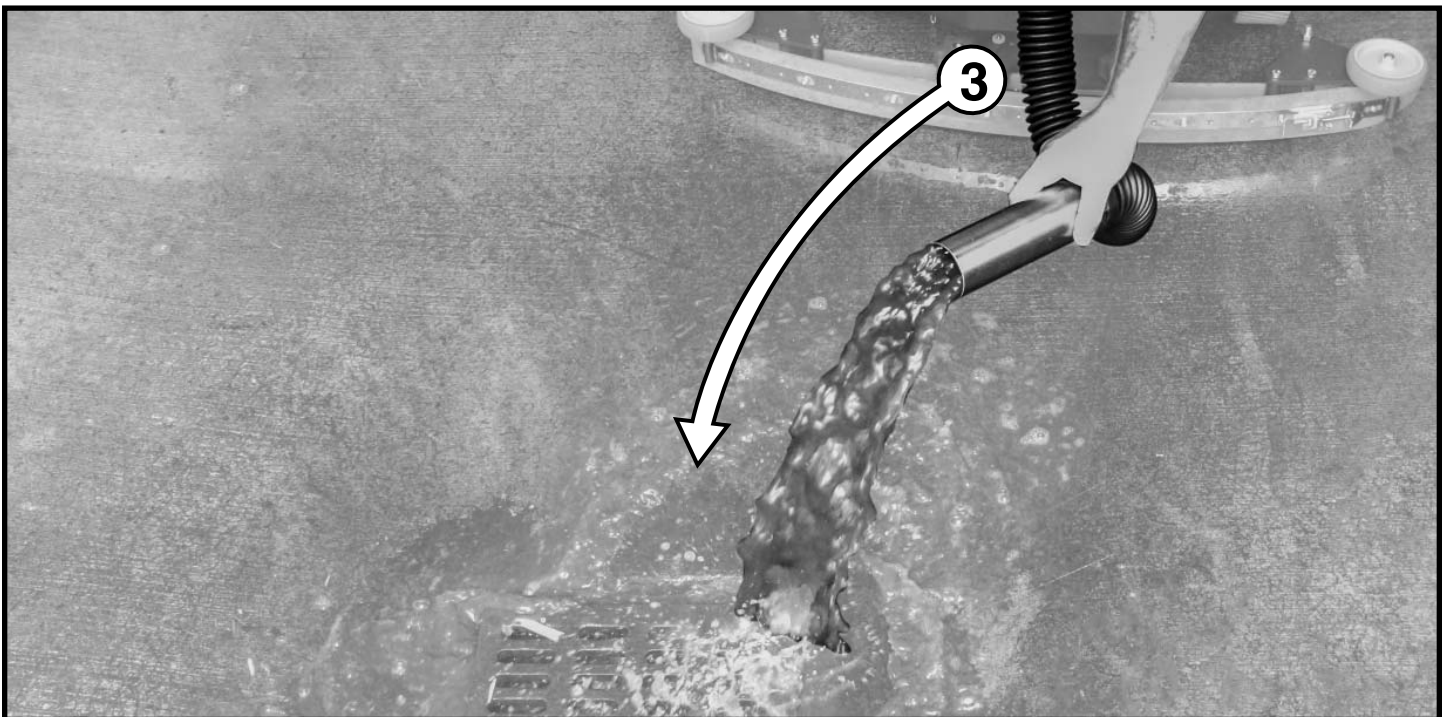
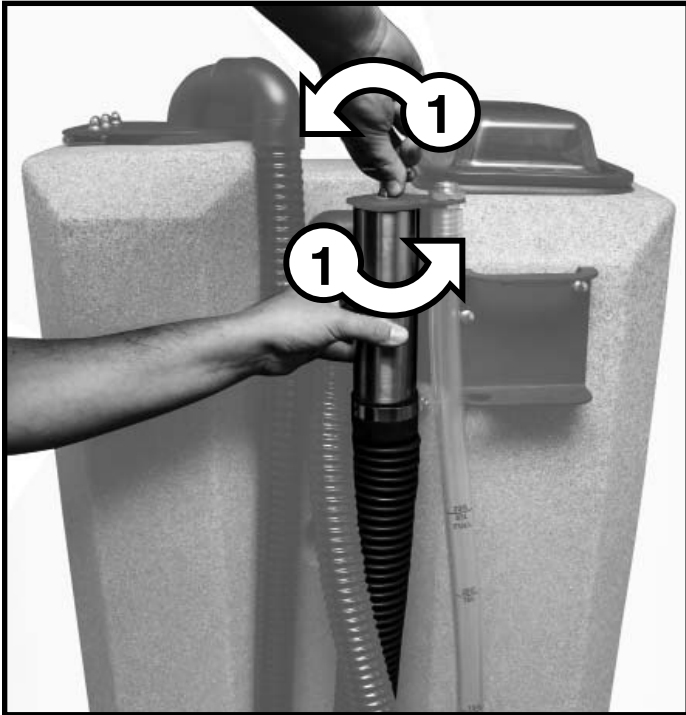

DRAINING SOLUTION TANK

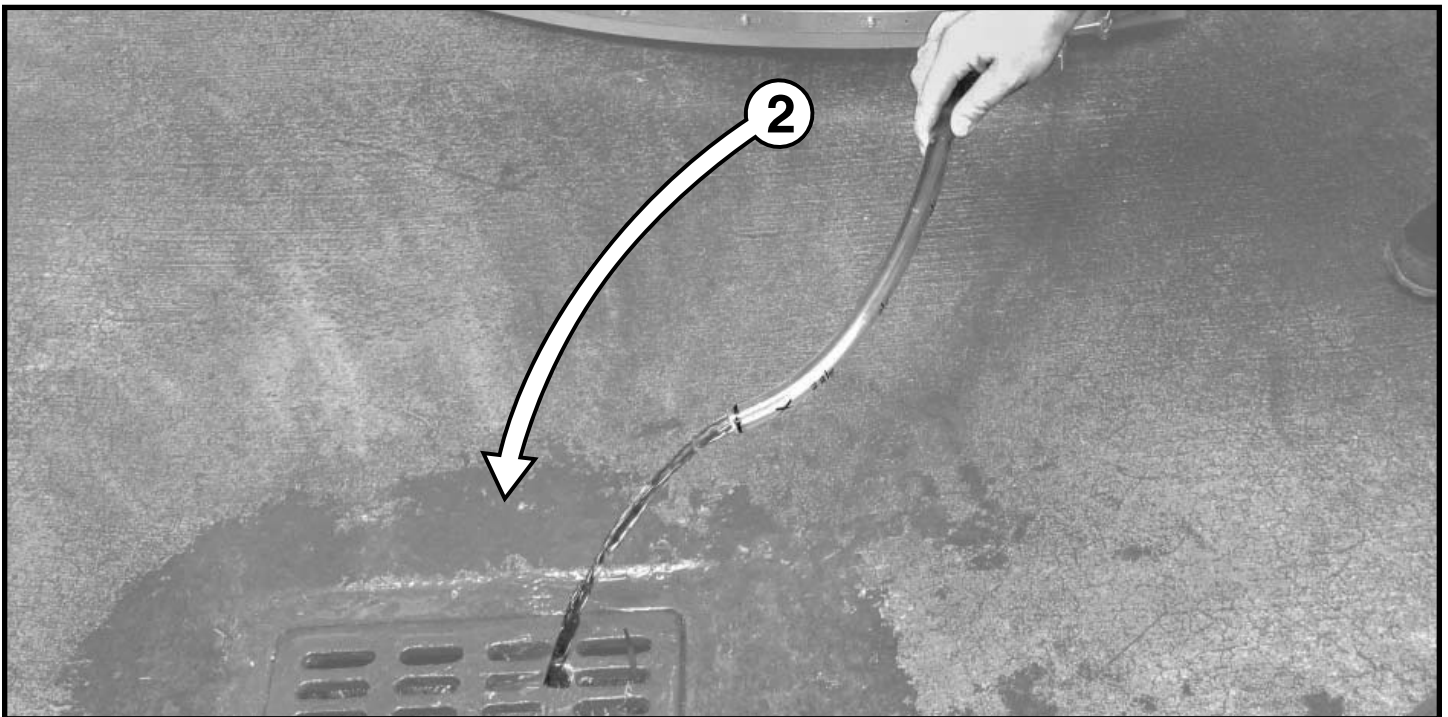
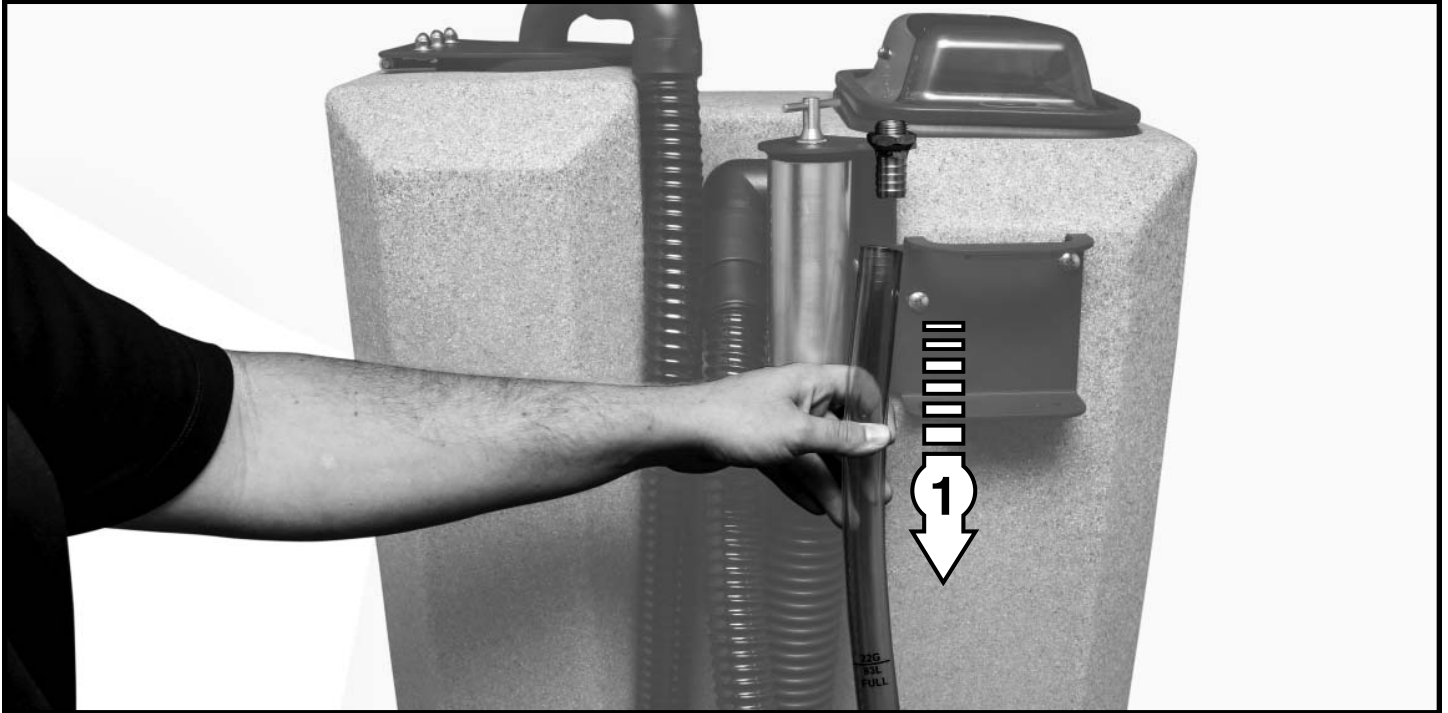

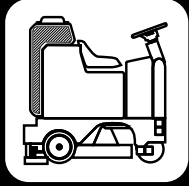

FLUSHING RECOVERY TANK

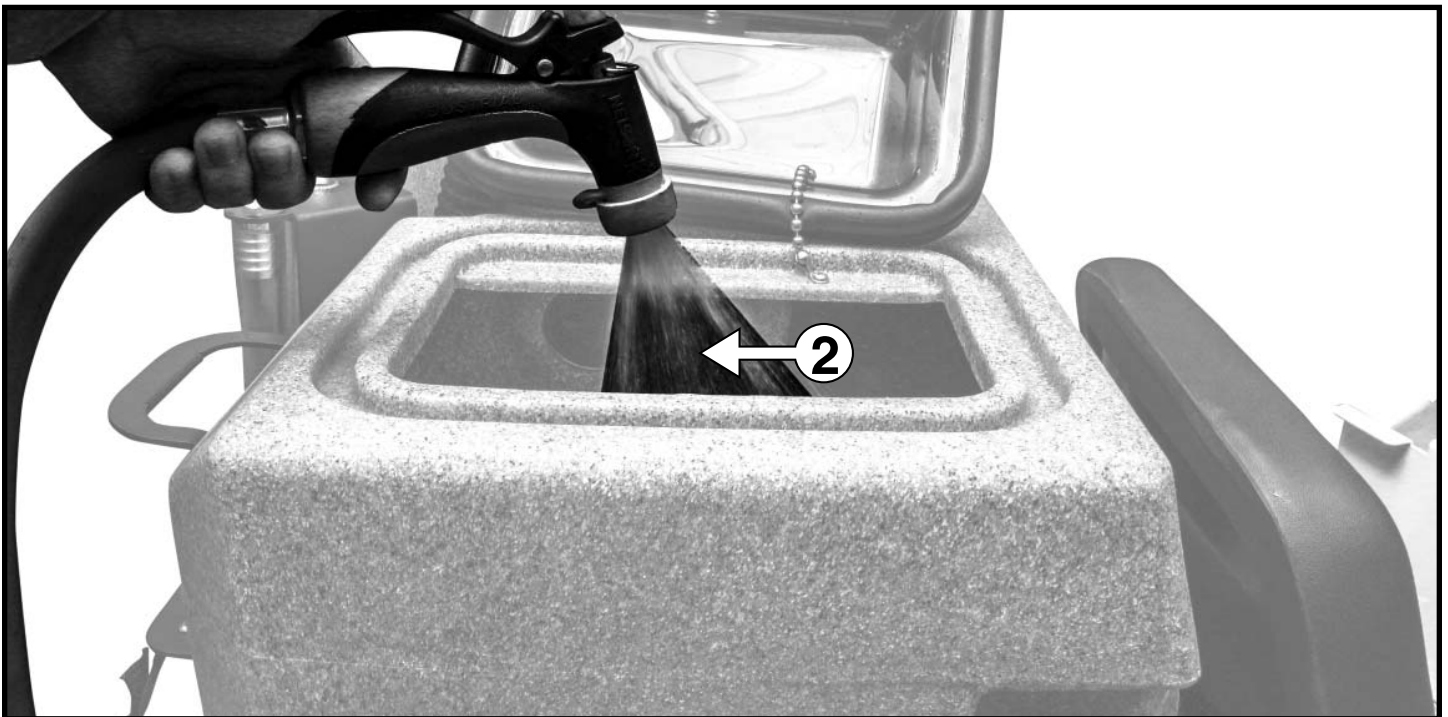

CLEAN DRAIN SAVER

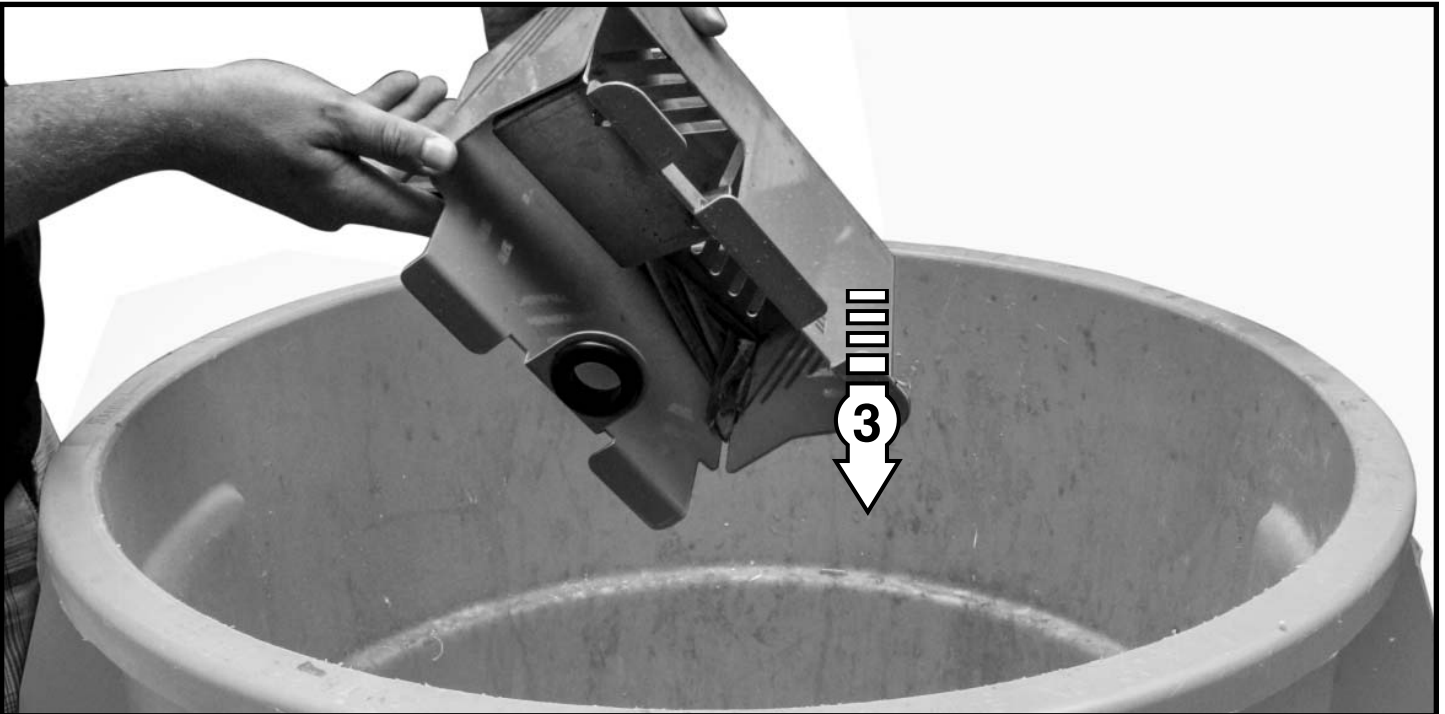



CLEAN CYLINDRICAL HOPPER

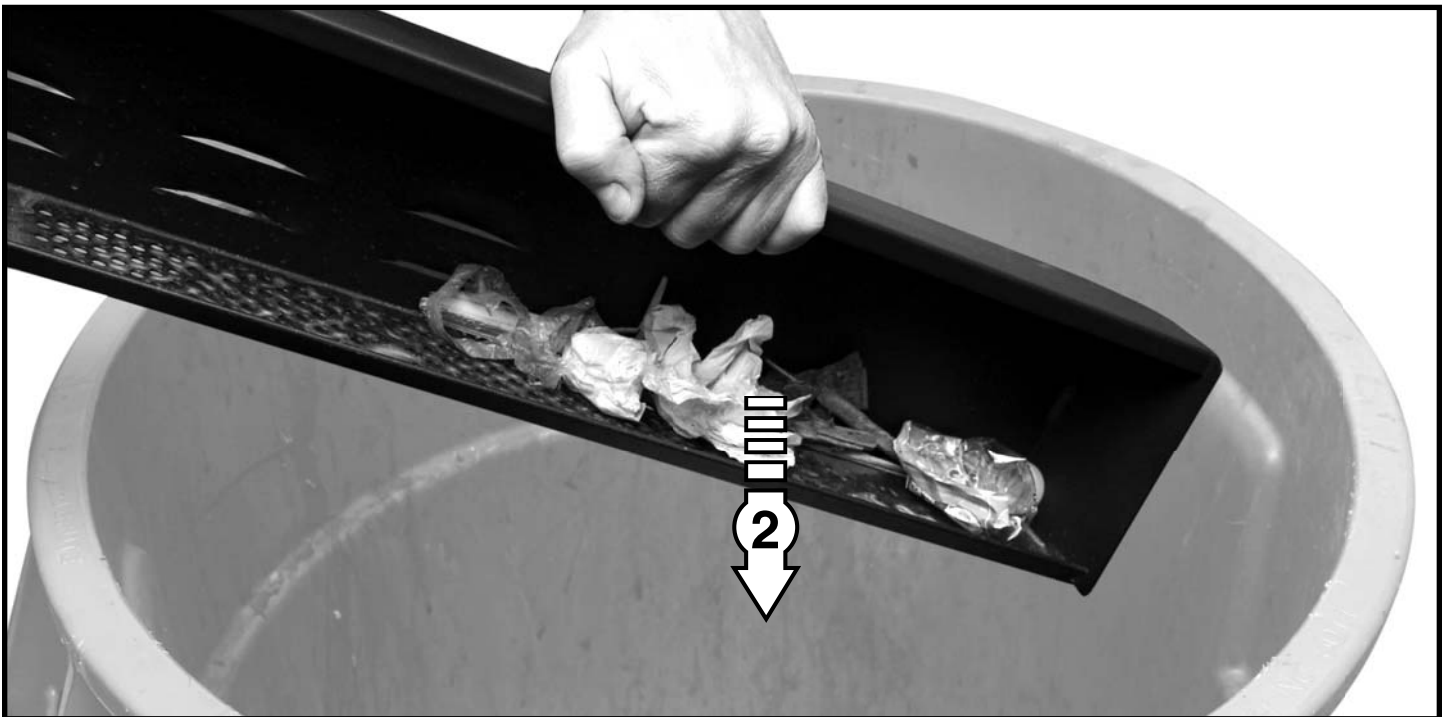
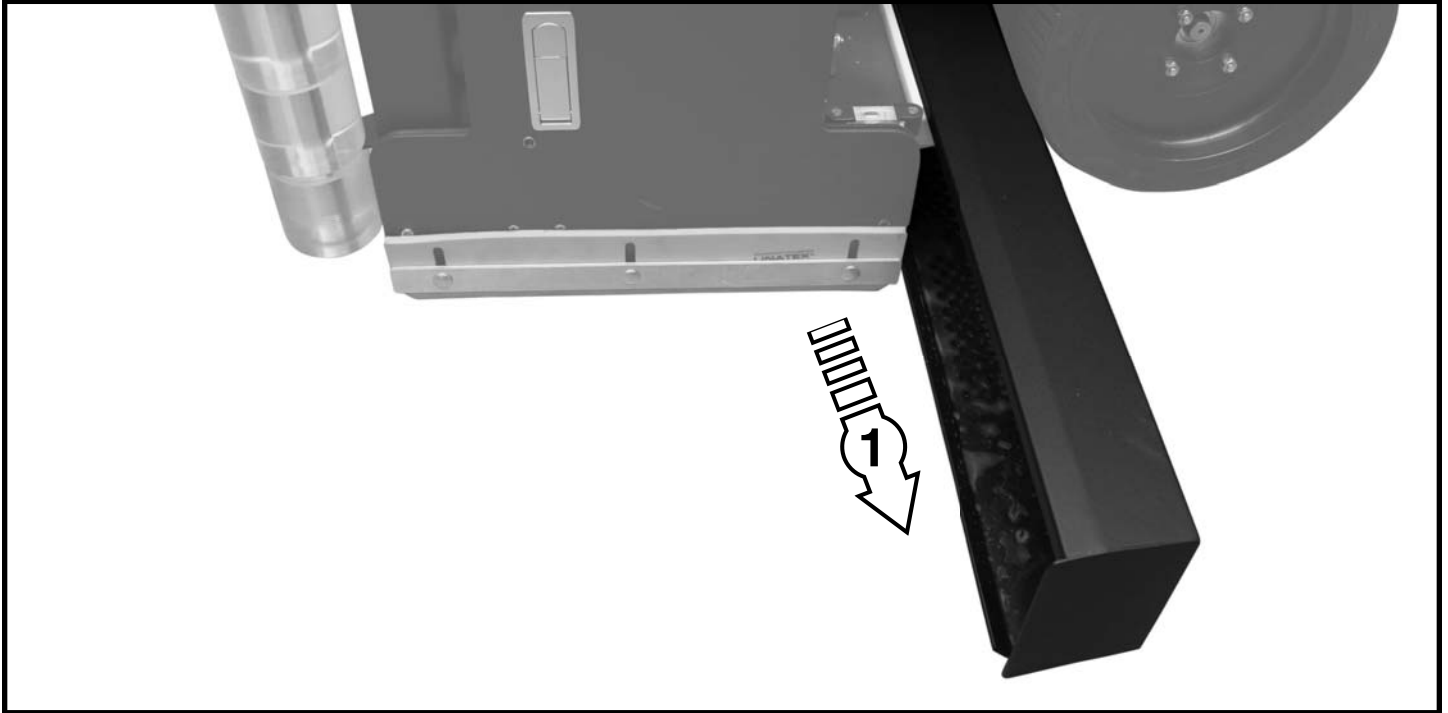

CLEAN VAC BOX SYSTEM

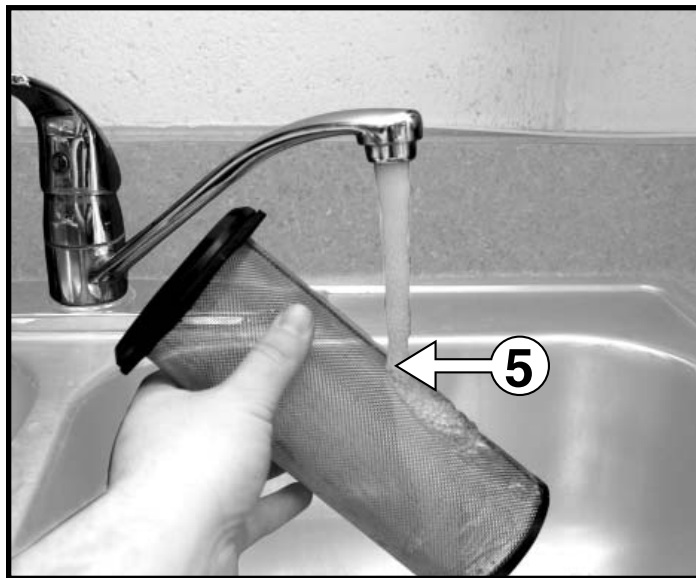
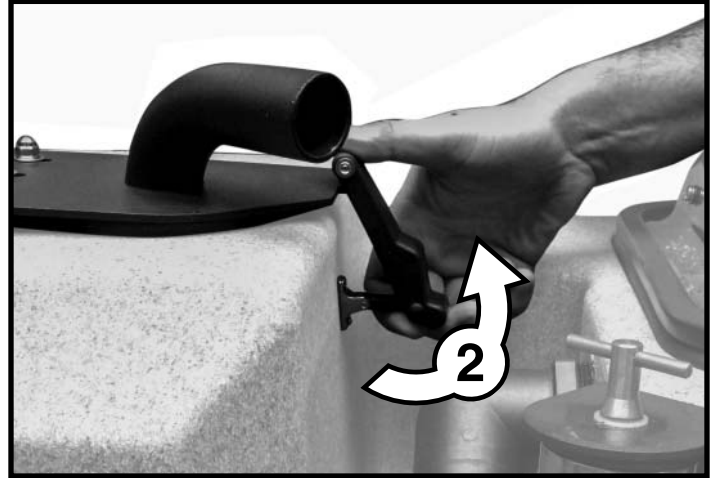

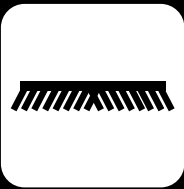

REMOVE DISK BRUSHES

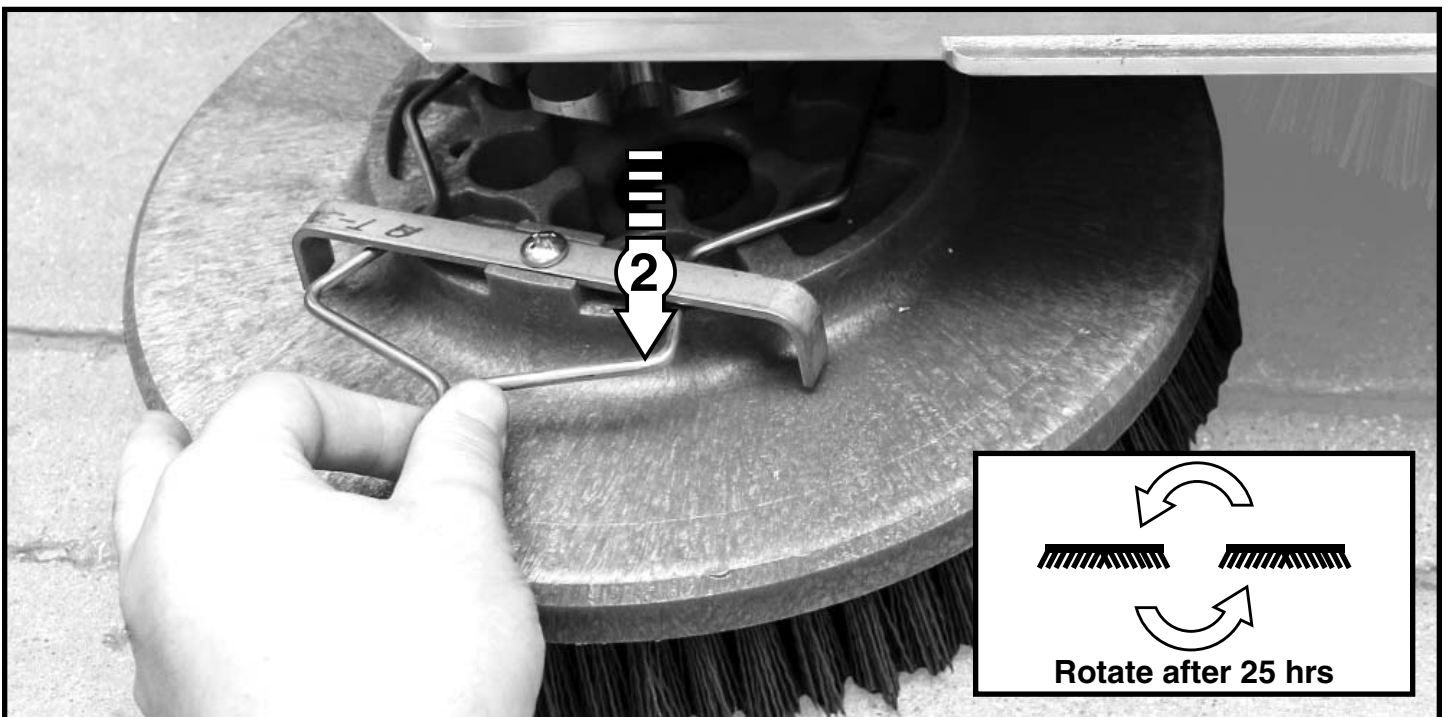

REMOVE CYLINDRICAL BRUSHES

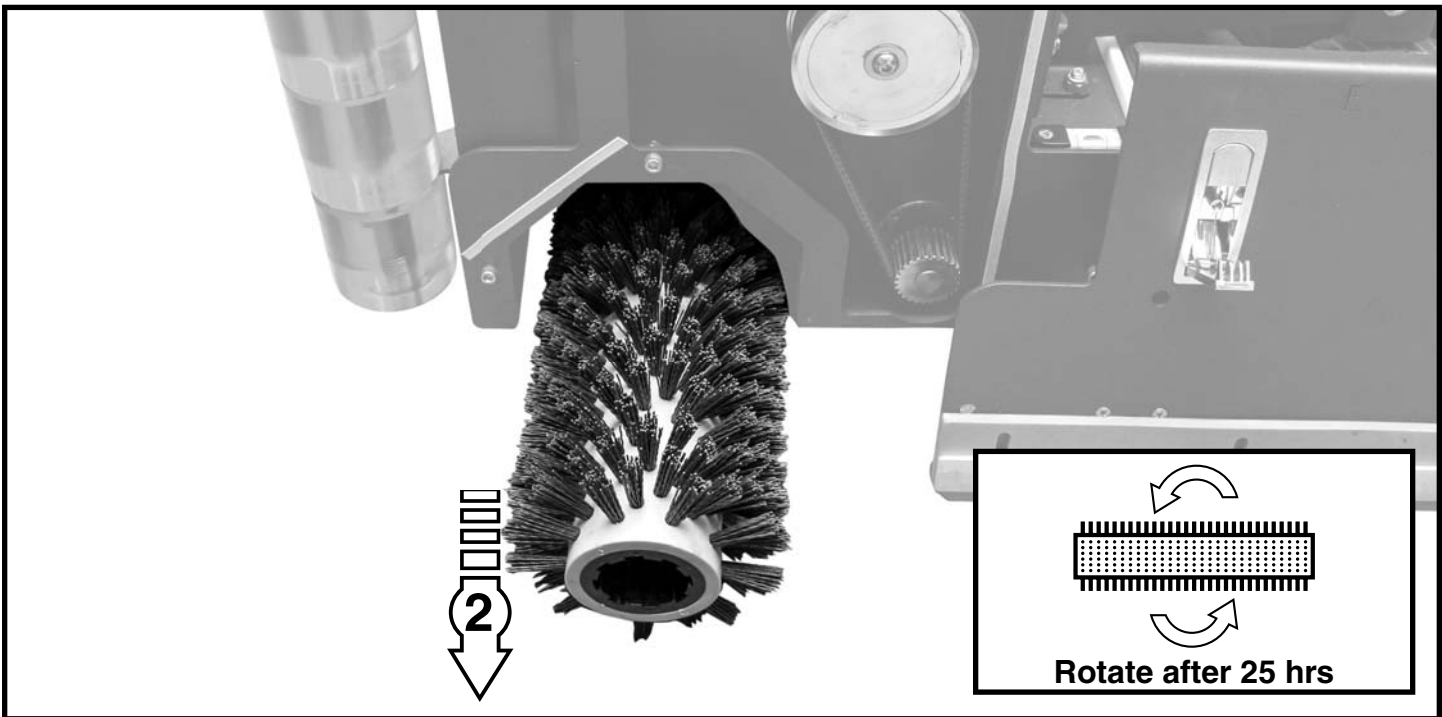
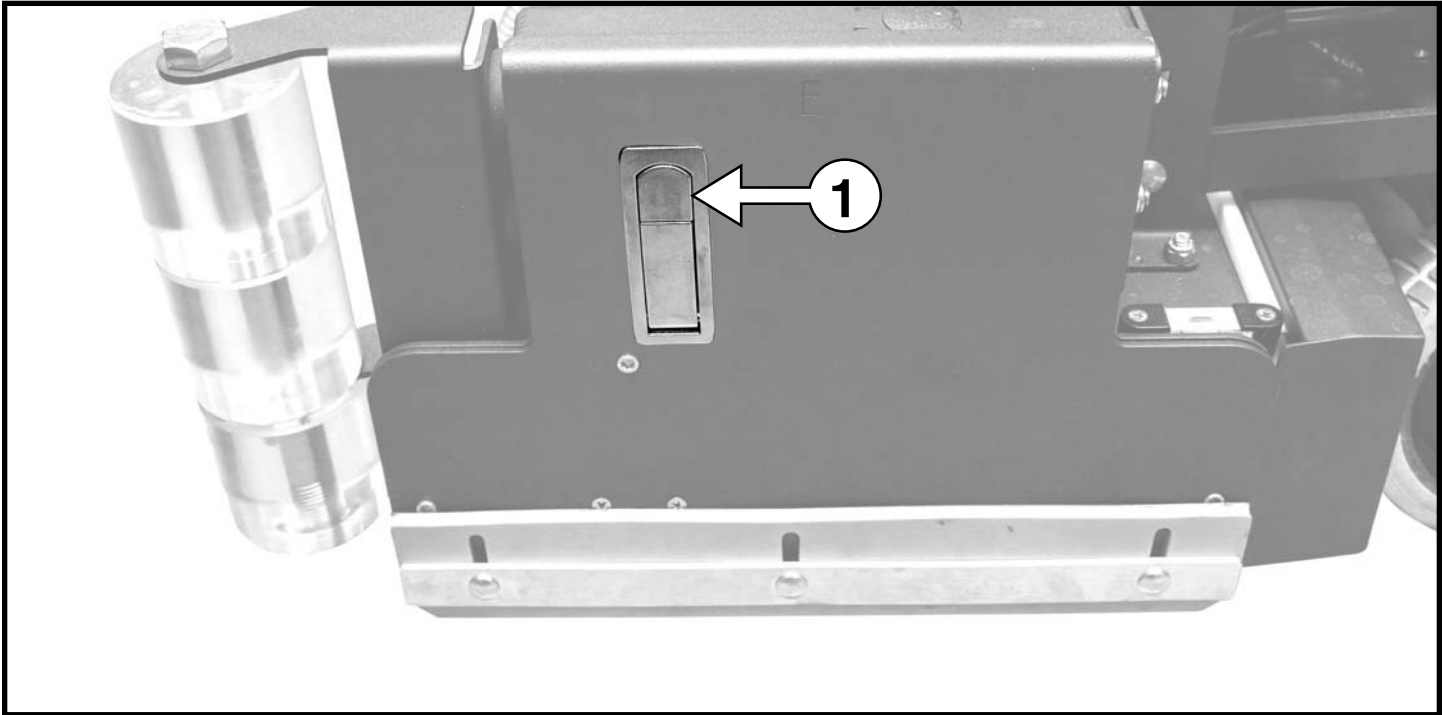
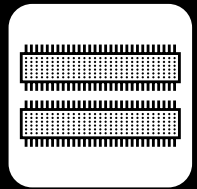

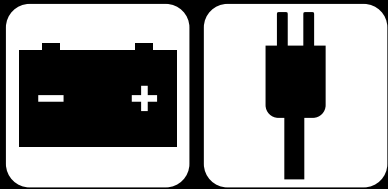

CHARGE BATTERIES

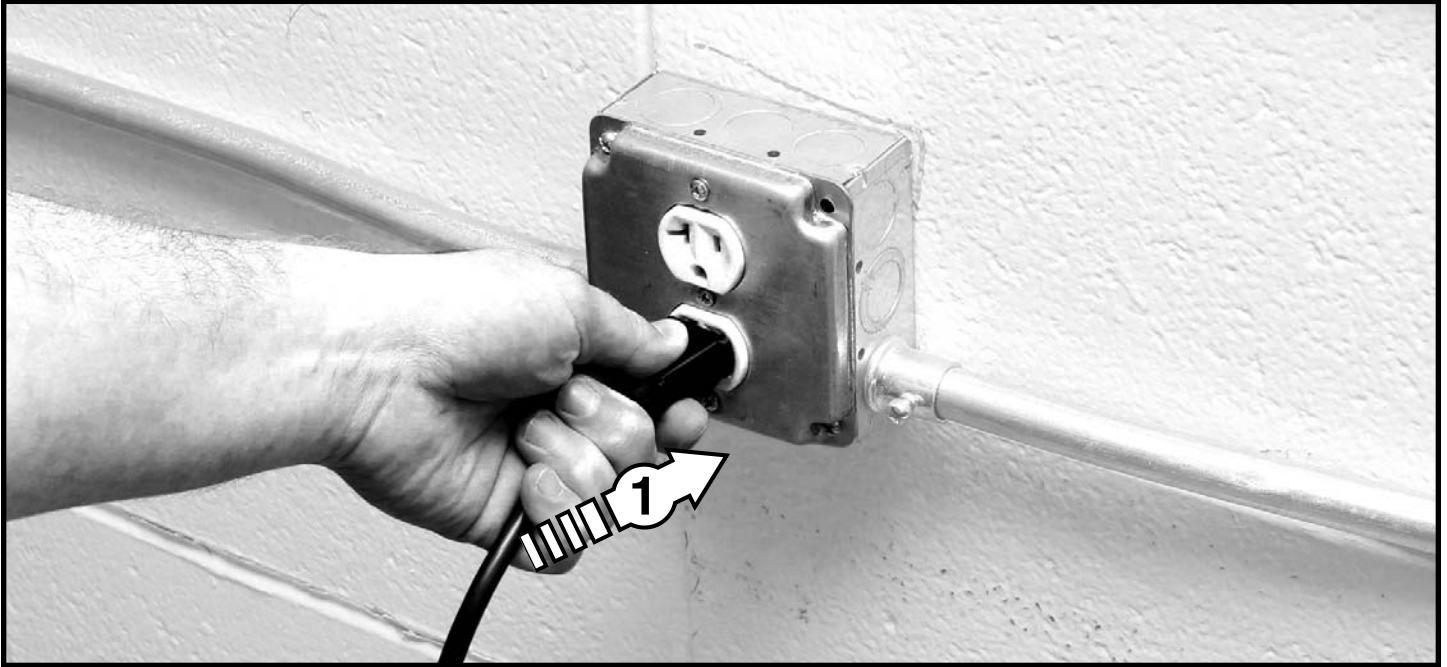

Please refer to OEM Charger Operating Instructions for more information.

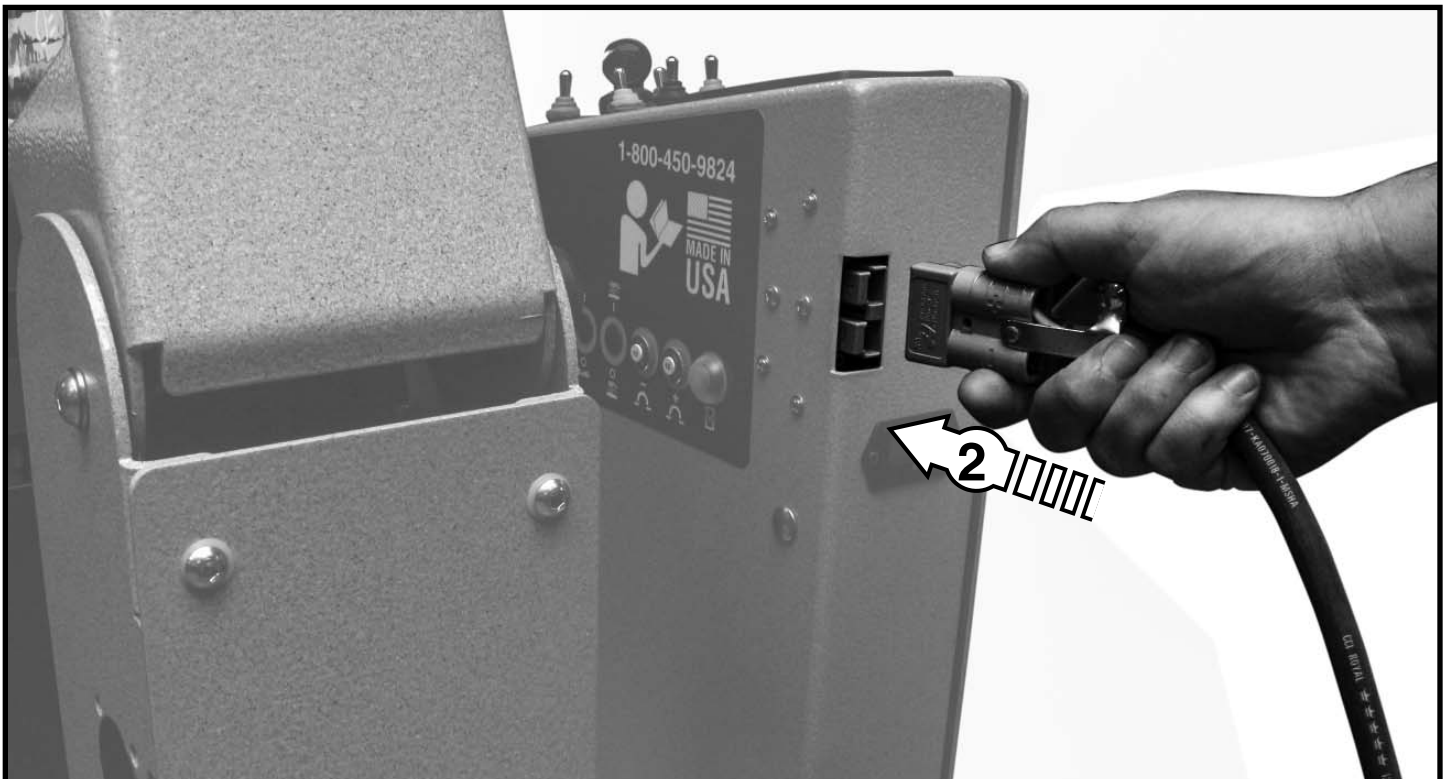

BATTERY CHARGERS

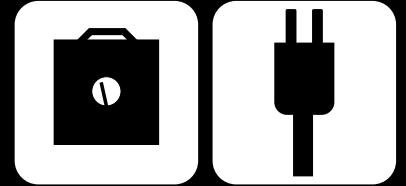

Console / WET / Domestic Chargers:

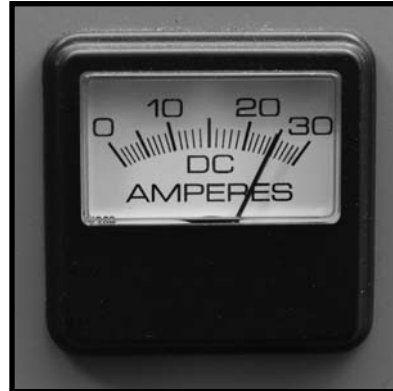

AC Power IN: 120VAC / 60Hz
DC Power OUT: 36VDC / 25A

Please refer to OEM Charger Operating Instructions for more information.



COMMON WEAR PARTS

ROUND DISK BRUSHES:

NOTICE

The ## in Disk Column Denotes Desk Pad Size: 13" or 14"

| BRUSHES | DISK | LEVEL |
|----------------|----------|-----------|
| Super Grit | ##-382SS | Very High |
| Tough Grit | ##-382S | High |
| Midi Grit | ##-382C | Medium |
| Light Grit | ##-382PS | Moderate |
| Poly | ##-382P | Light |
| Nylon | ##-382N | Light |
| Tampico | ##-382T | Light |
| Pad Driver | ##-382D | |
| Diamond Driver | ##-382DD | |

ROUND DISK PADS:

NOTICE

The ## in Disk Column Denotes Desk Pad Size: 13" or 14"

| DISK PADS | DISK | LEVEL | COLOR |
|-------------|----------|-----------|-------|
| Super Black | ##-422BB | Very High | Black |
| Black | ##-422B | High | Black |
| Brown | ##-422BR | High | Brown |
| Green | ##-422G | Medium | Green |
| Blue | ##-422BL | Moderate | Blue |
| Red | ##-422R | Moderate | Red |
| White | ##-422W | Light | White |

CYLINDRICAL BRUSHES:

| BRUSHES | MODEL 25" CYLINDRICAL | LEVEL |
|------------|-----------------------|----------|
| Tough Grit | 236-697S | High |
| Midi Grit | 236-697C | Medium |
| Light Grit | 236-697PS | Moderate |
| Nylon | 236-697N | Light |
| Tampico | 236-697T | Light |

EDGE PADS AND SCREENS:

| DESCRIPTION | 24"×14" | 28"×14" |
|----------------------|-----------|-----------|
| | SCRUBDECK | SCRUBDECK |
| White Pad | N/A | EDGE-4054 |
| Red Pad | EDGE-2404 | EDGE-4053 |
| Blue Pad | EDGE-2403 | EDGE-4052 |
| Green Pad | EDGE-2402 | EDGE-4051 |
| Black Pad | EDGE-2401 | EDGE-4050 |
| White Driver Pad | N/A | EDGE-4058 |
| 60 Grit Sand Screen | N/A | EDGE-4059 |
| 80 Grit Sand Screen | N/A | EDGE-4060 |
| 100 Grit Sand Screen | N/A | EDGE-4061 |
| 120 Grit Sand Screen | N/A | EDGE-4062 |
| 150 Grit Sand Screen | N/A | EDGE-4063 |
| 20 Grit Sand Paper | N/A | N/A |
| 36 Grit Sand Paper | N/A | N/A |
| 60 Grit Sand Paper | N/A | N/A |

| | | |
|---------------------------------|-----------|-----------|
| 80 Grit Sand Paper | N/A | N/A |
| 100 Grit Sand Paper | N/A | N/A |
| 400 Grit Diamond Polishing Pad | N/A | EDGE-4013 |
| 800 Grit Diamond Polishing Pad | N/A | EDGE-4014 |
| 1500 Grit Diamond Polishing Pad | N/A | EDGE-4015 |
| 3000 Grit Diamond Polishing Pad | N/A | EDGE-4016 |
| 6000 Grit Diamond Polishing Pad | N/A | EDGE-4070 |
| Tile/Grout Renovator Pad | N/A | EDGE-4048 |
| Dominator HD Strip Pad | N/A | EDGE-4055 |
| Maroon ECO Prep Pad | EDGE-2407 | EDGE-4056 |

SQUEEGEE BLADE KITS & COMPLETE SQUEEGEE ASSEMBLIES:

| SQUEEGEE SIZE | 26" DISK DECKS | 28" DISK DECKS | 25" CYL. DECKS |
|---------------|----------------|----------------|----------------|
| 36" Squeegee | Standard | Optional | Standard |
| 42" Squeegee | Optional | Standard | Optional |

| SQUEEGEE SIZE | LINATEX BLADE KIT | GUM RUBBER BLADE KIT | URETHANE BLADE KIT | COMPLETE SQUEEGEE ASSEMBLIES |
|---------------|-------------------|----------------------|--------------------|------------------------------|
| 36" Squeegee | 36-770L | 36-770G | 36-770U | 36-7180 |
| 42" Squeegee | 42-770L | 42-770G | 42-770U | 42-7180 |

| SQUEEGEE MATERIAL: | USED FOR: |
|--------------------|---|
| LINATEX | Provides best wear and tear resistance. Not designed for use with harsh chemicals. |
| URETHANE | Provides best resistance when dealing with harsh chemicals, oils, fuels, etc. |
| GUM | Provides best drying performance on rough/grouted floor types by sealing over irregularities. Short life. |

NOTICE

Squeegee blade kits include (1) Rear Blade, (1) Front Blade, and (2) Caster Wheels with hardware.

NOTICE

Squeegee Assemblies (complete) listed above all come with Linatex blades.

NOTICE

Size is stamped into the top of the painted steel squeegee body on all squeegee's.



BLANK

THIS PAGE WAS INTENTIONALLY LEFT BLANK

BLANK

THIS PAGE WAS INTENTIONALLY LEFT BLANK

FACTORYCAT[®]

1711 South Street
Racine, WI 53404
www.factorycat.com
Tel. US: 800-634-4060
Tel. Int: (001) 262-681-3583